

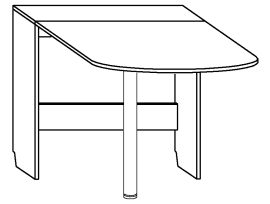









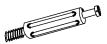



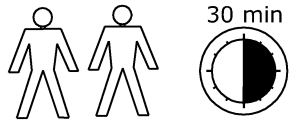

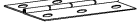
EXPERT 6

-17/80+75/80

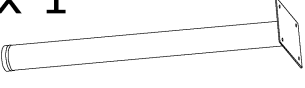
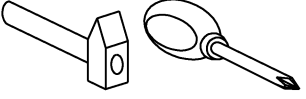

x 12  (a)		x 4  (b)	x 4  (c)	x 2  (d)	x 1  (e)		
x 1  (f)	x 2  (g)	x 12 (3,5 x 16)  (h)	x 4 (6,2 x 13)  (i)	x 1 (6,2 x 30)  (j)	x 4  (l)		x 1  (m)
x 1  (k)							

1 - FAZY MONTAŻU

A - OZNACZENIE ELEMENTÓW

a - OZNACZENIE AKCESORIÓW

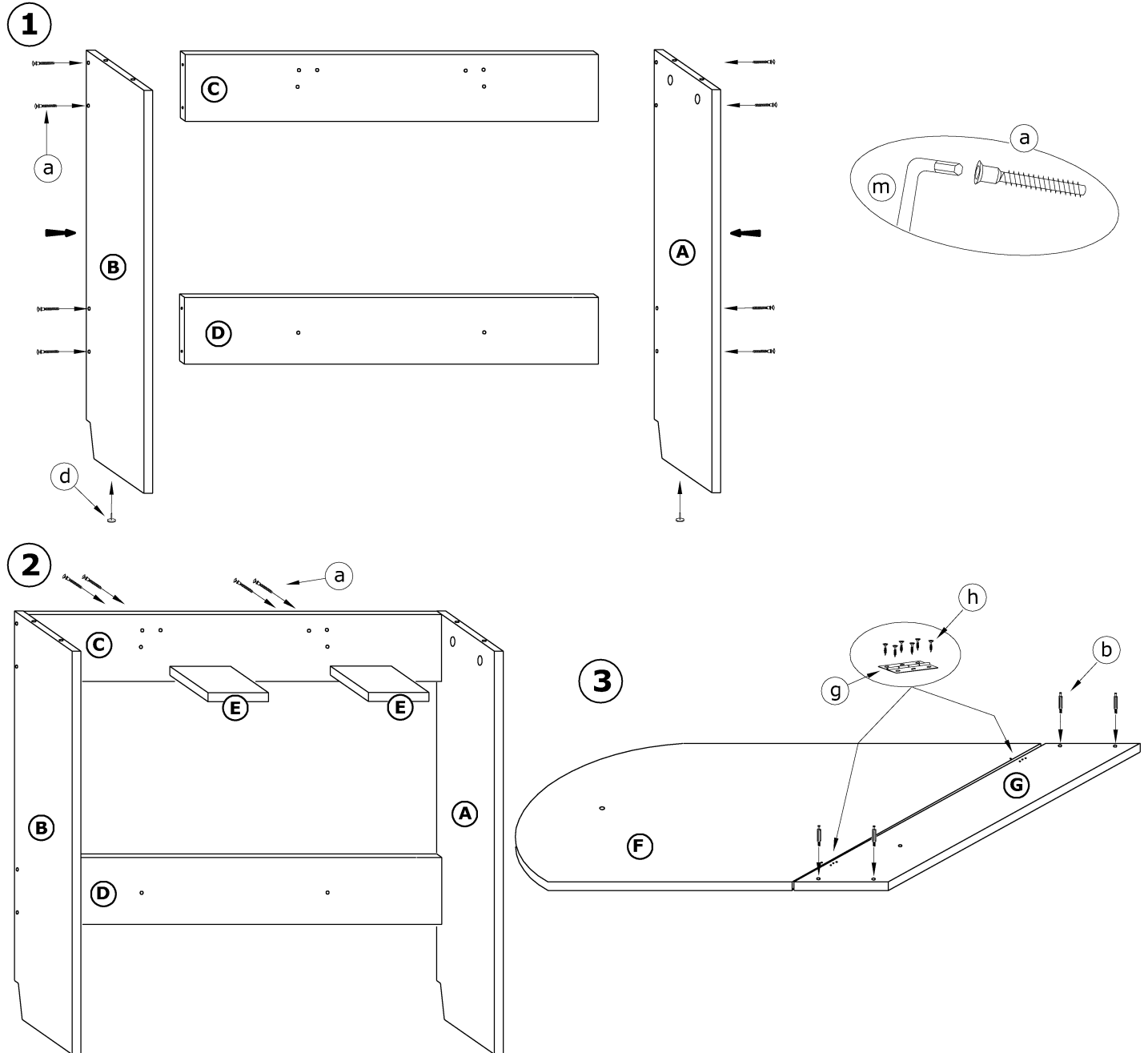

4

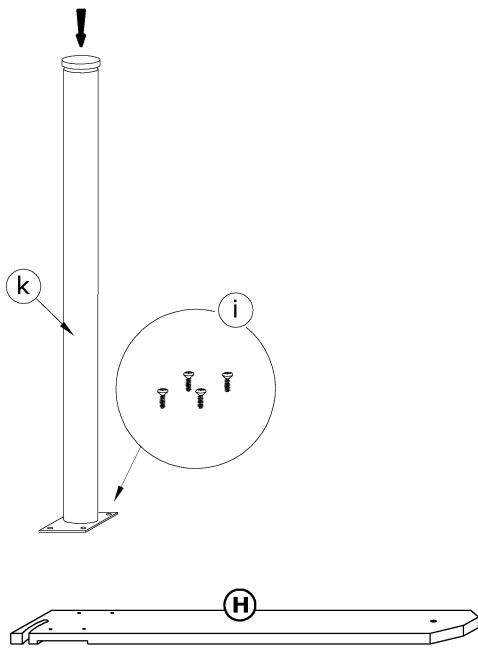

5

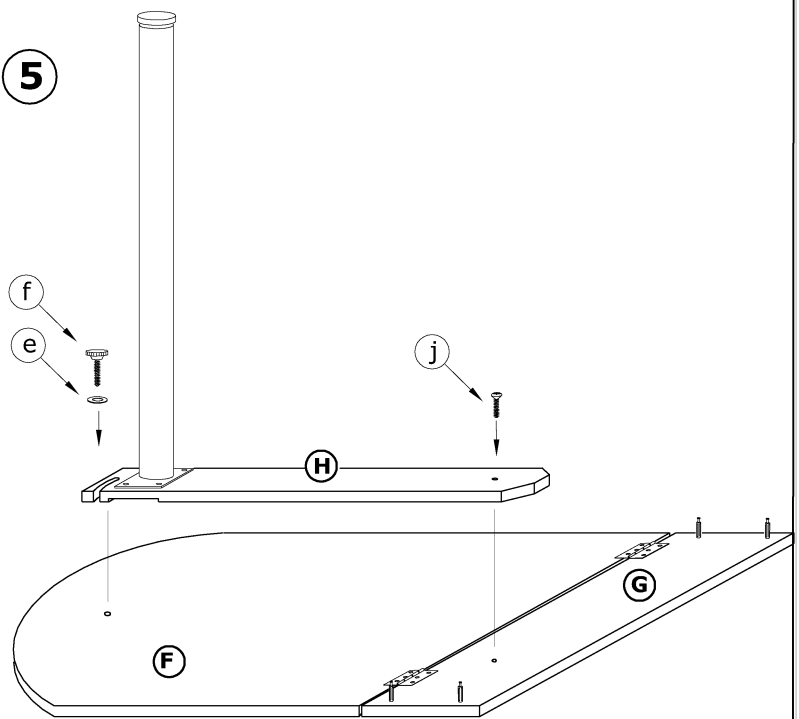

5

