

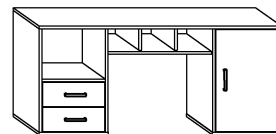



















HANGER

→ 140 × 63 × 42

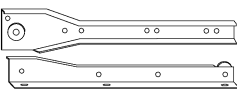
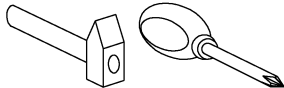

x 24  a	x 10  b	x 14  c	x 14  d	x 2  e	x 2  f			
x 5 kpl.  h	x 3  i	x 4  j	x 5  k	x 28 (3,5x16)  l	x 8 (3,5x30)  m	x 10 (6,2x13)  n	x 20  o	x 1  p
x 2 kpl. (350 mm)  g								

1 - FAZY MONTAŻU

A - OZNACZENIE ELEMENTÓW

a - OZNACZENIE AKCESORIÓW

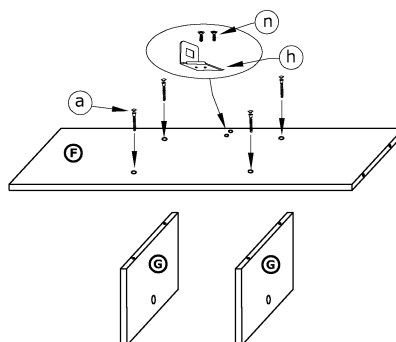
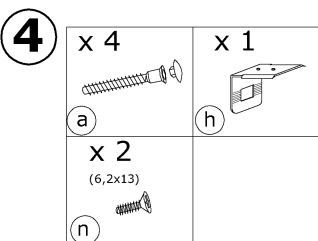
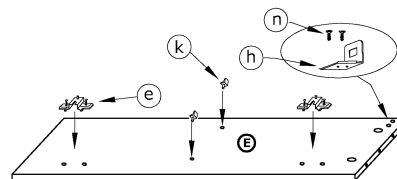
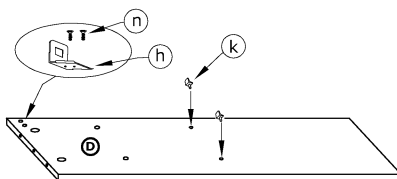
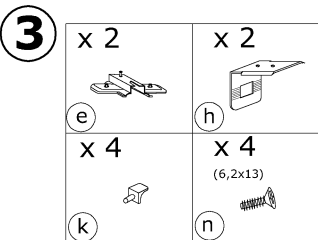
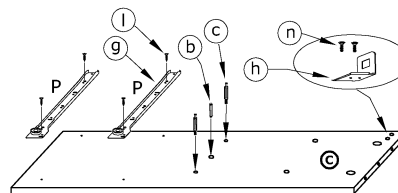
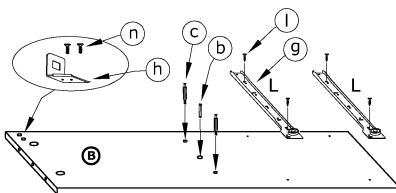
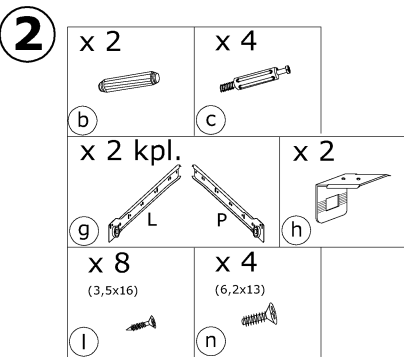
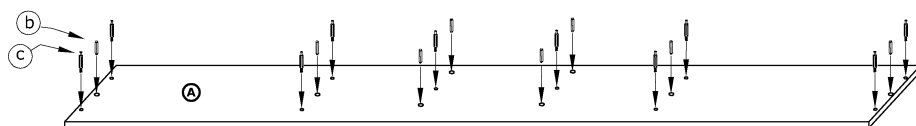
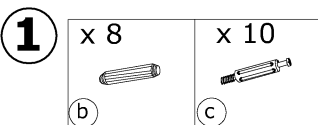

5

- x 4
- a
- x 4
- d

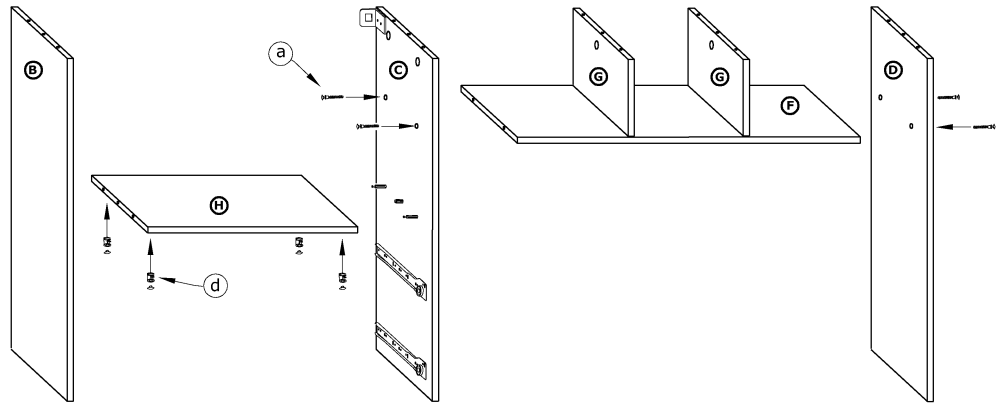

6

- x 8
- a
- x 10
- d

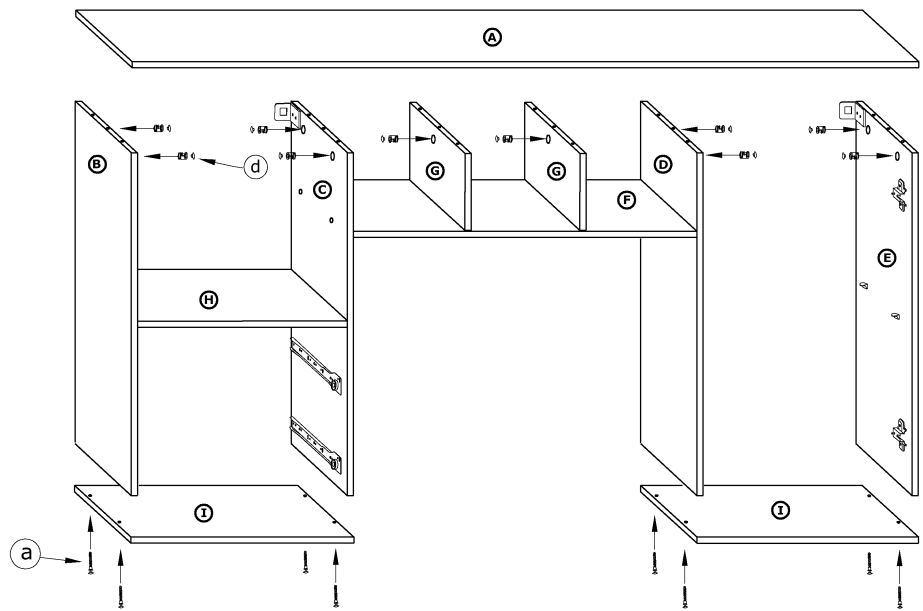

7

- x 8
- a
- x 20
- o

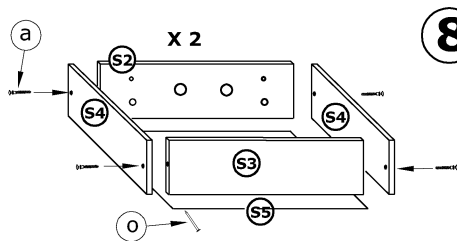

8

- x 2 kpl.
- g
- x 2
- i
- x 12 (3,5x16)
- l
- x 4
- j
- x 4 (3,5x30)
- m

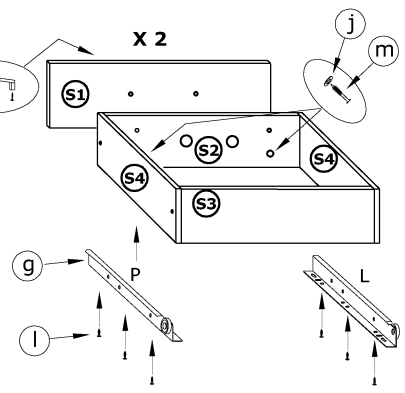

9

- x 2
- f
- x 1
- i
- x 4 (3,5x16)
- l
- x 4 (3,5x30)
- m

