

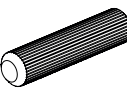

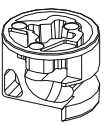







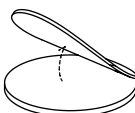

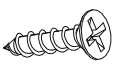
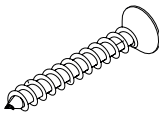
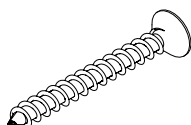
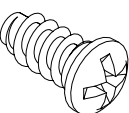
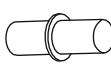
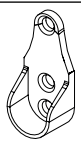
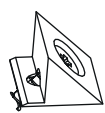
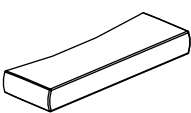
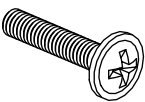
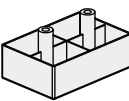
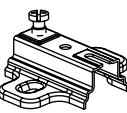
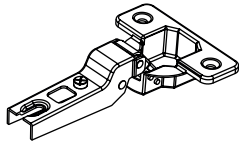
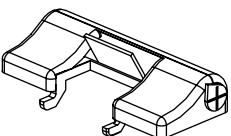

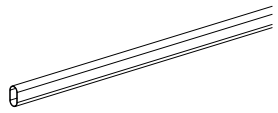
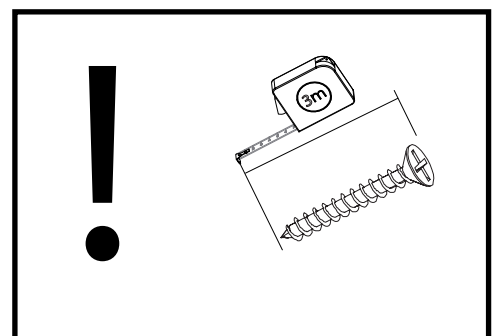
DALLAS 01

GW1 x 8 1,4x25 	K1 x 16 8x32 	B2 x 20 h-12 
ZJ1 x 20 L-43 	ZS2 x 20 Ø20 	ZS1 x 16 Ø13 
WT1 x 20 3,5x15 	WT20 x 12 4x25 	WT38 x 18 4x45 
WE2 x 16 EK6,3x13B 	PO2 x 4 Ø5 	UBO x 2 
SP x 10 	UCH x 2 	WT19 x 4 4x22M 
ST5 x 5 60x40x20 	PK4 x 8 H-4 	ZP12 x 8 1/2 
SDO x 4 	LT x 1 L- 1953 	D x 1 L- 849 



DALLAS 01

	CODE				
1	Dallas01_02	915	615	1	1/5
2	Dallas01_05	800	80	2	1/5
3	Dallas01_10	1068	402	1	4/5
4	Dallas01_14	397	200	2	5/5
5	Dallas01_03	1954	614	1	2/5
6	Dallas01_06	1953,5	80	1	2/5
7	Dallas01_09	855	482	1	1/5
8	Dallas01HDF_01	1966	433	2	2/5
9	Dallas01_08	856	564	1	1/5
10	Dallas01_04	1954	614	1	3/5

	CODE				
11	Dallas01_07	1953,5	80	1	3/5
12	Dallas01_01	915	615	1	1/5
13	Dallas01_11	1068	402	1	4/5
14	Dallas01_12	749	402	1	4/5
15	Dallas01_13	749	402	1	4/5

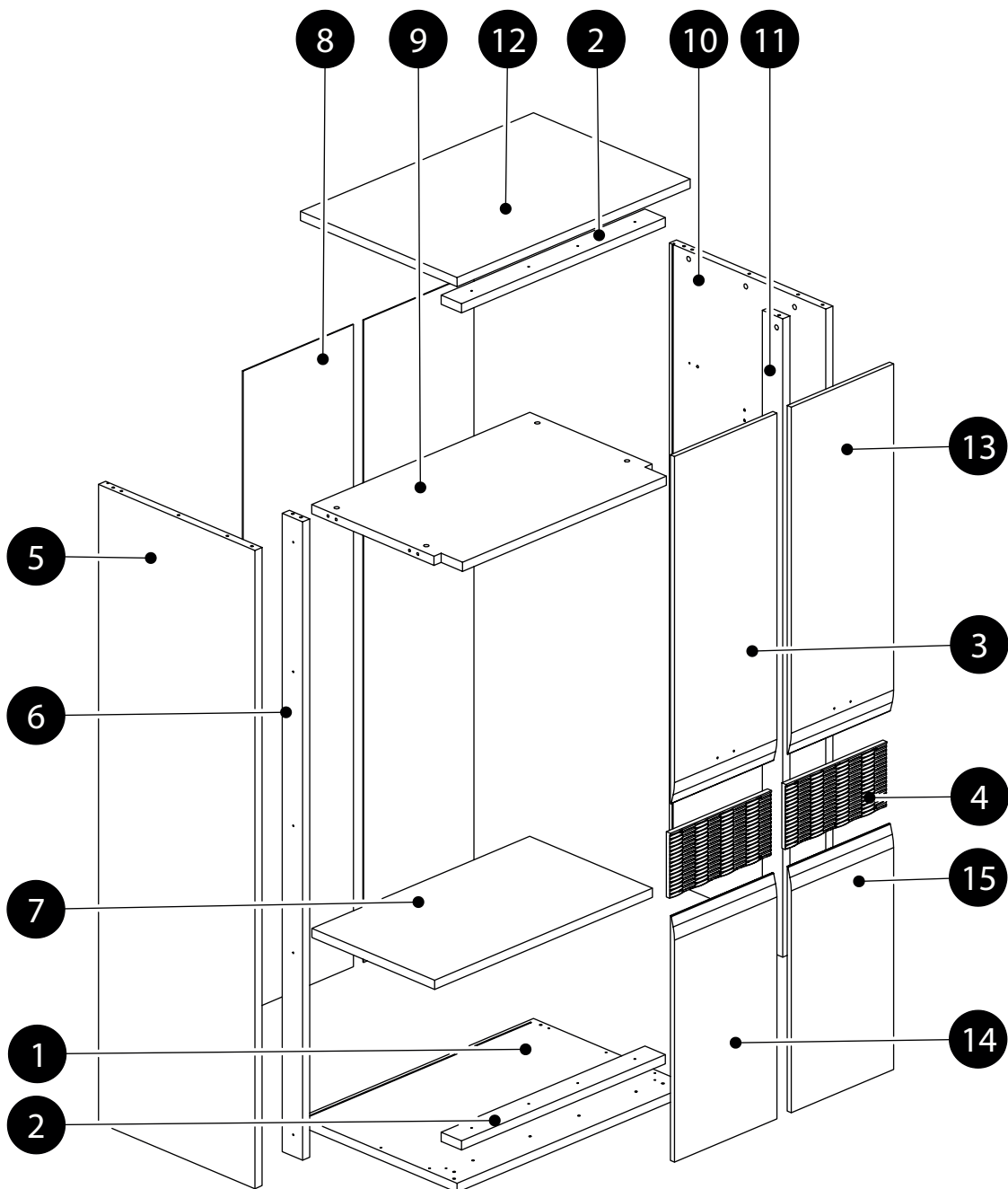

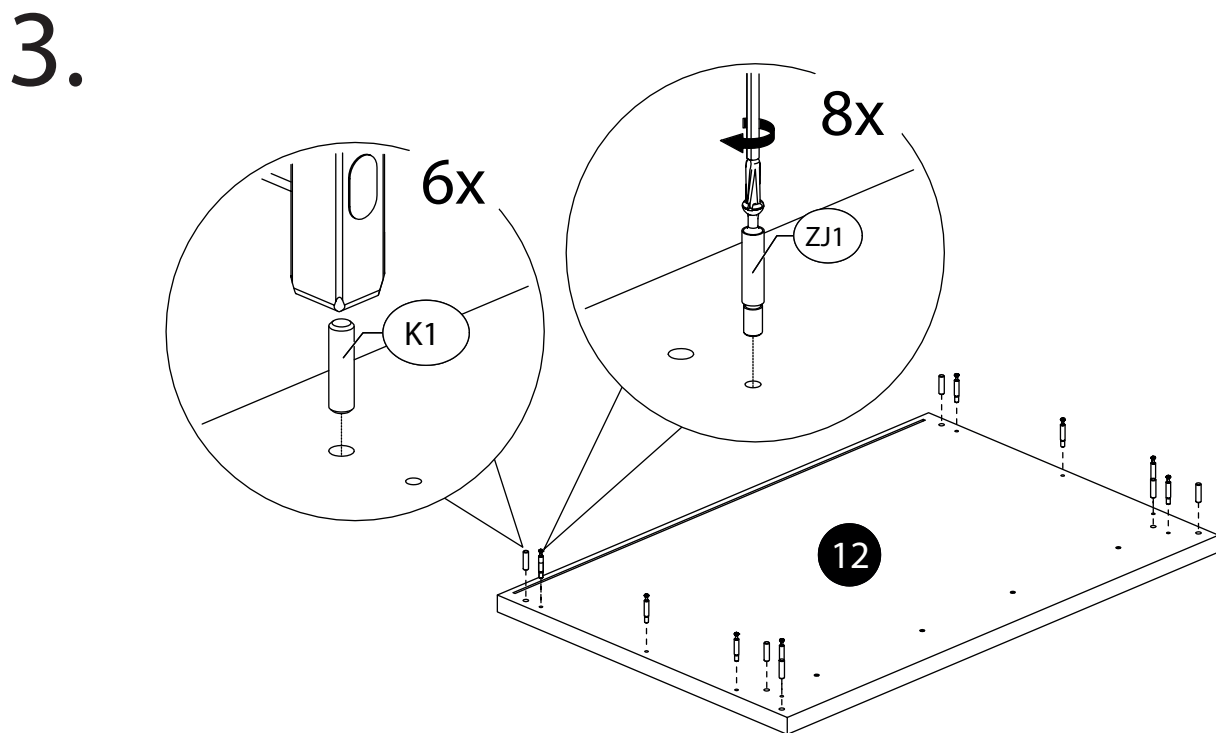
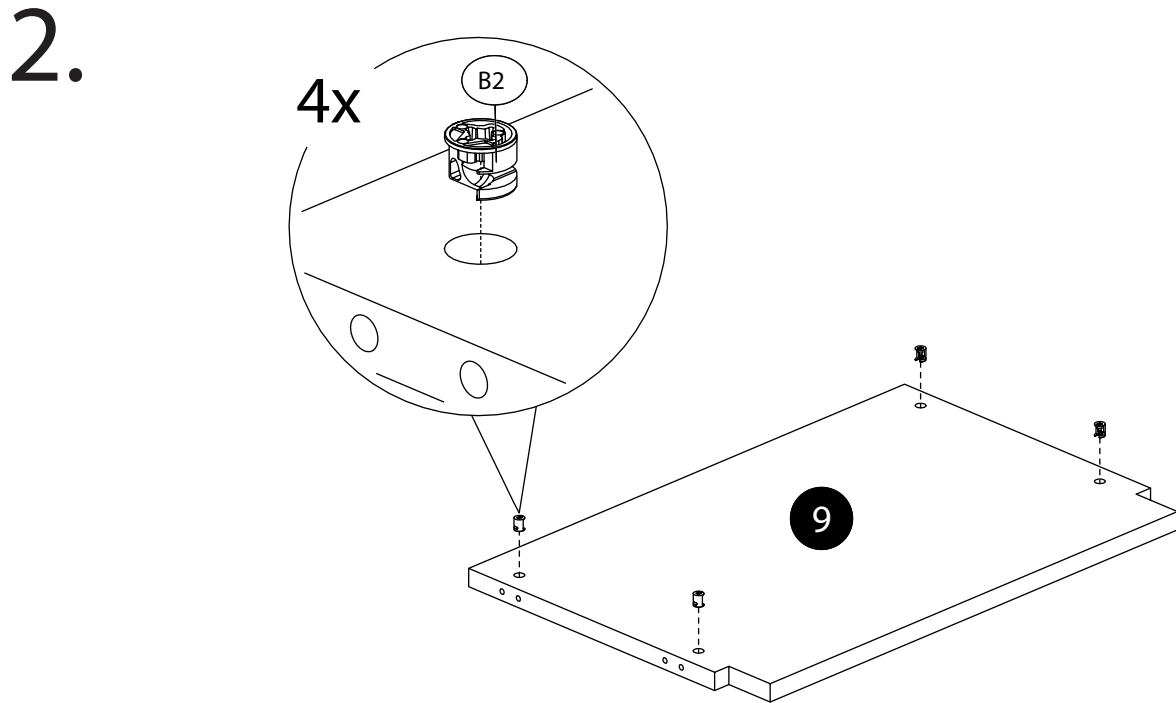
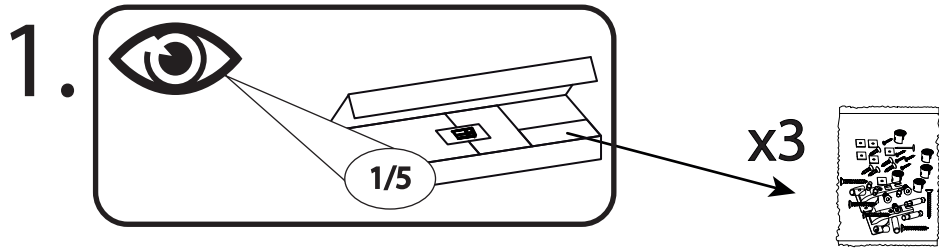

4.

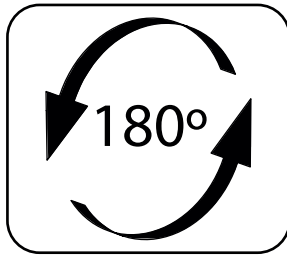
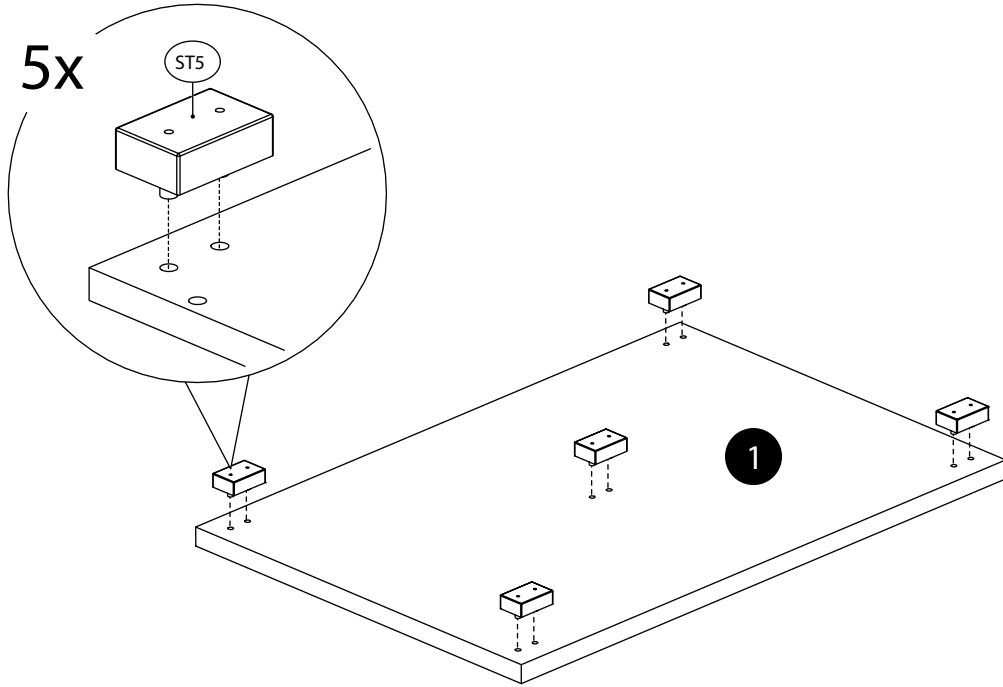

5.

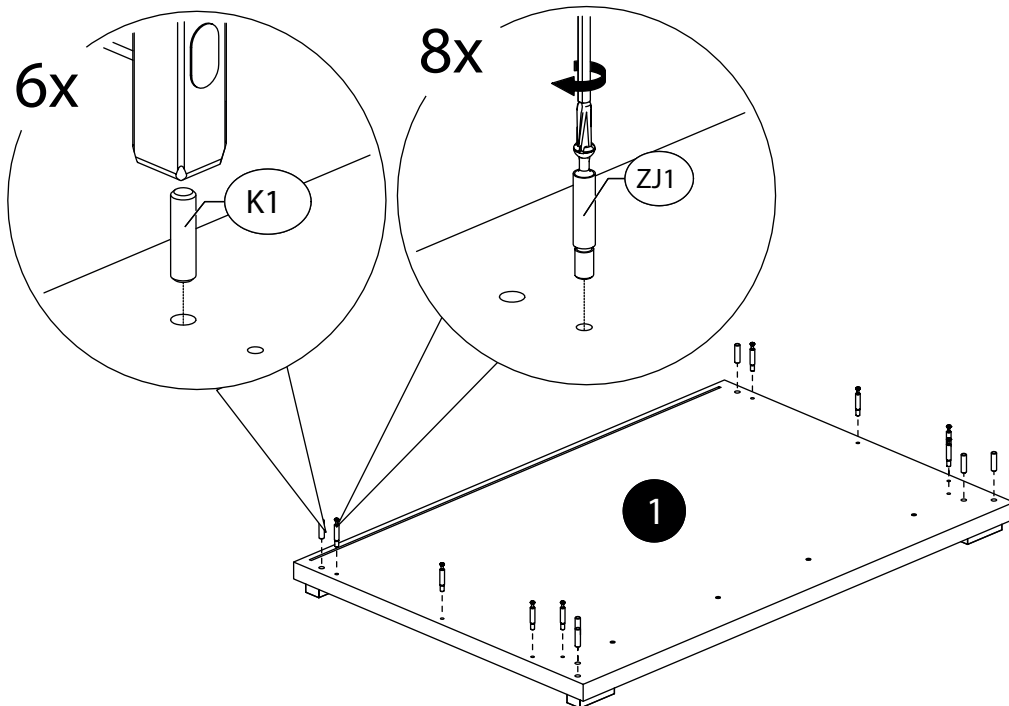

6.

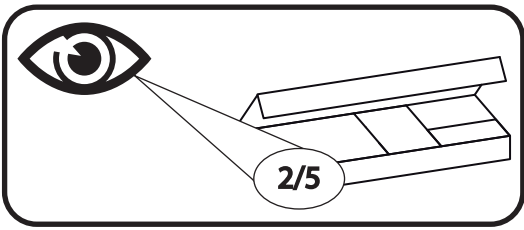

7.

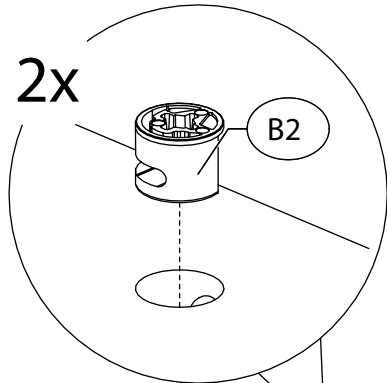
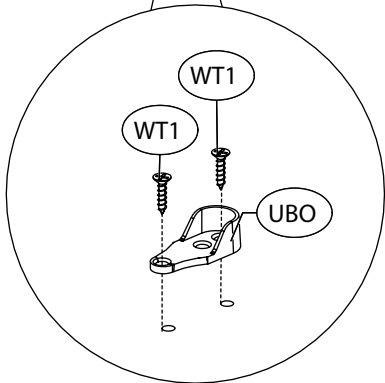
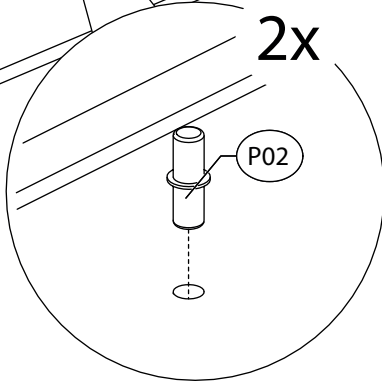
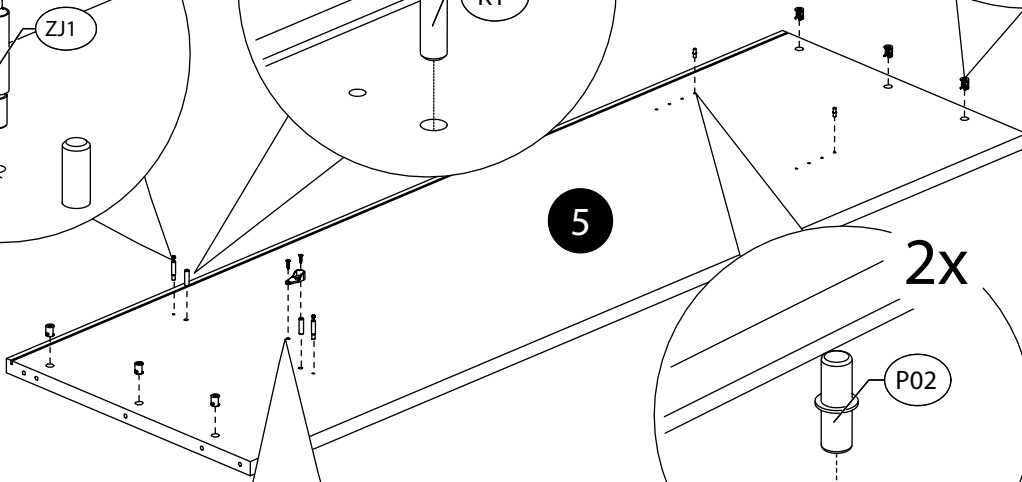
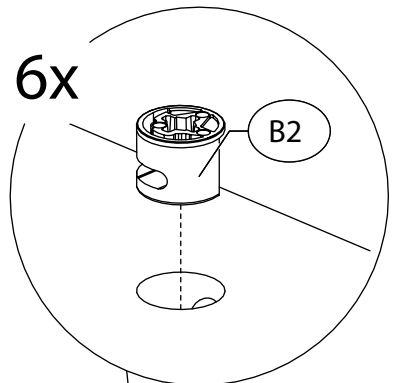
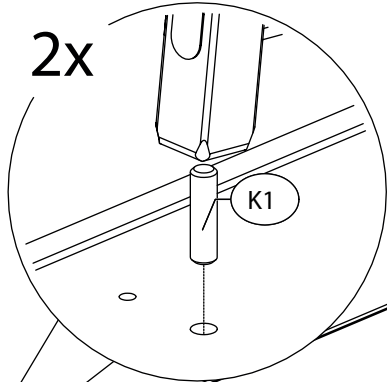
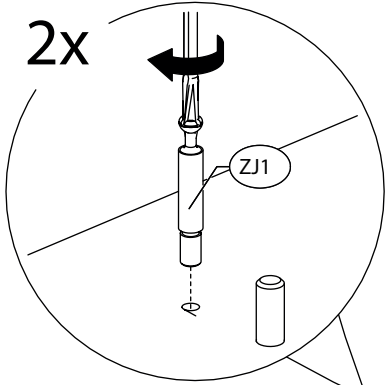

8.

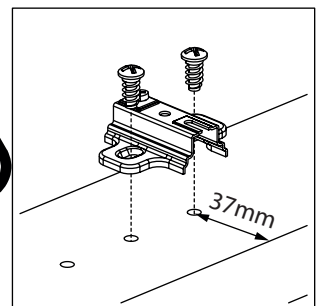
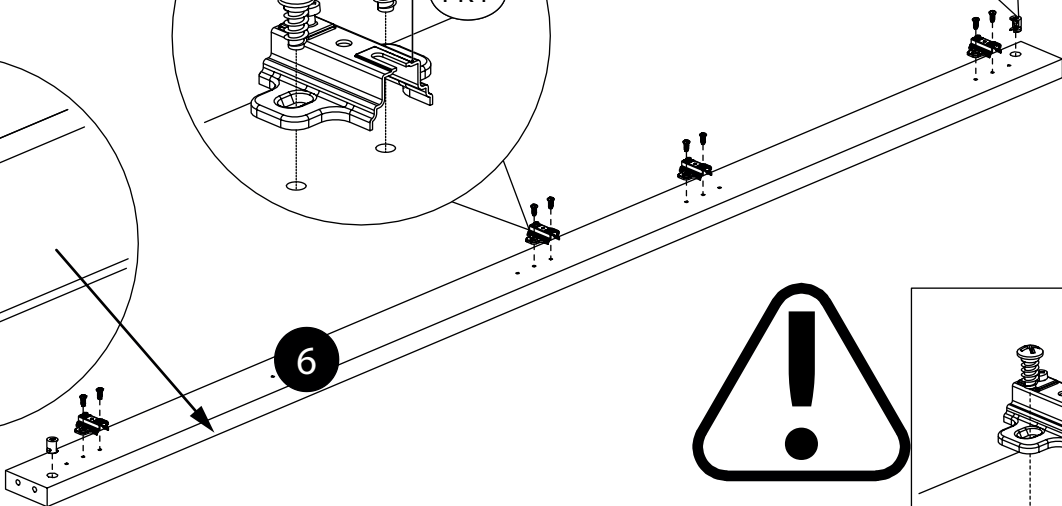
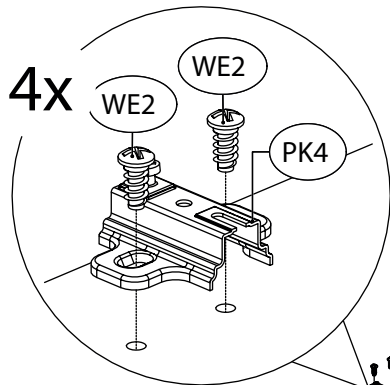
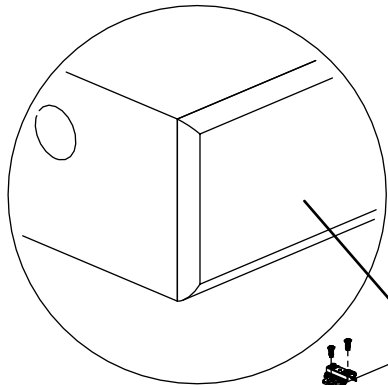

9.

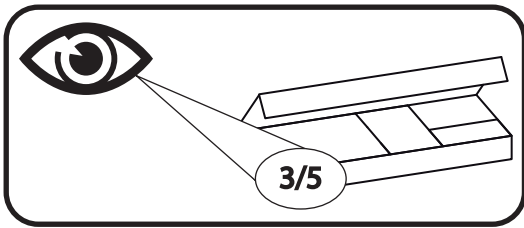

2x

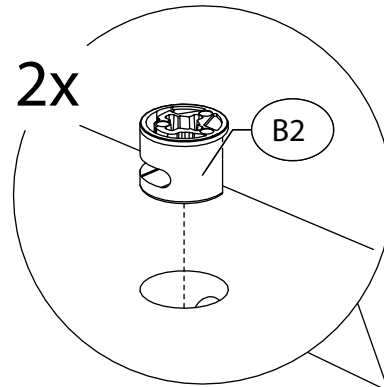

10.

4x

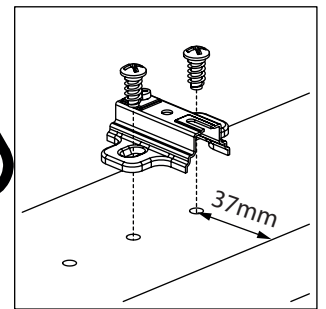
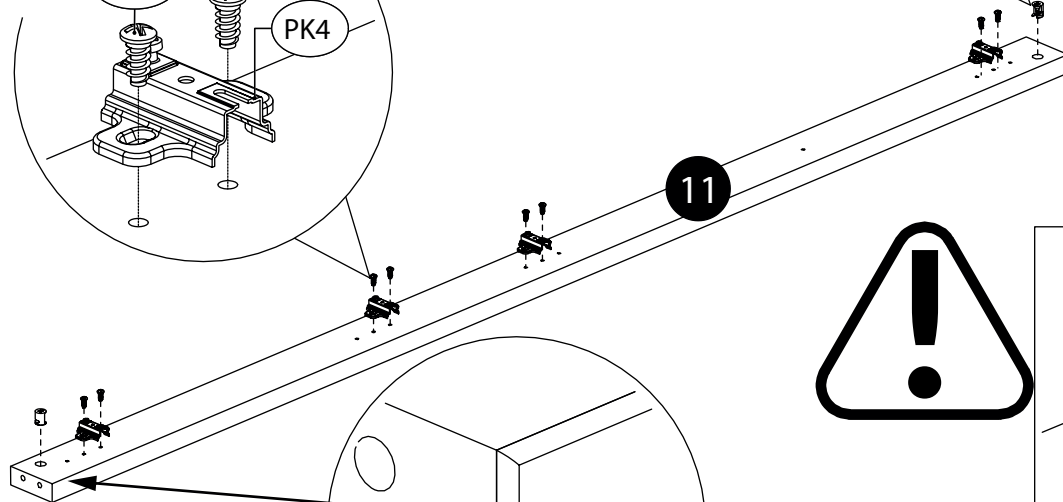
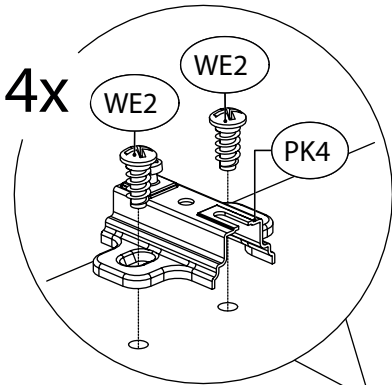

11.

2x

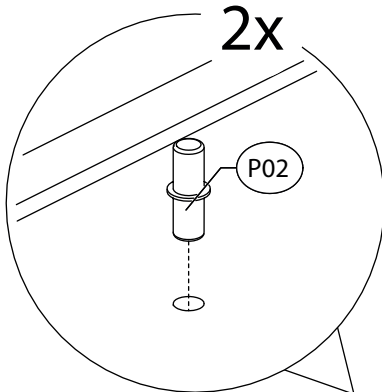

2x

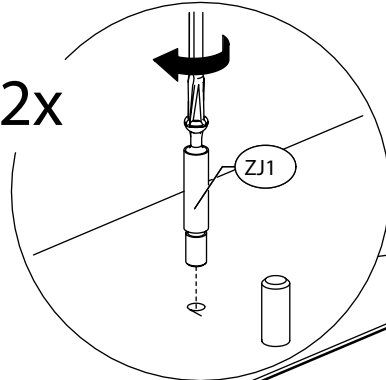

2x

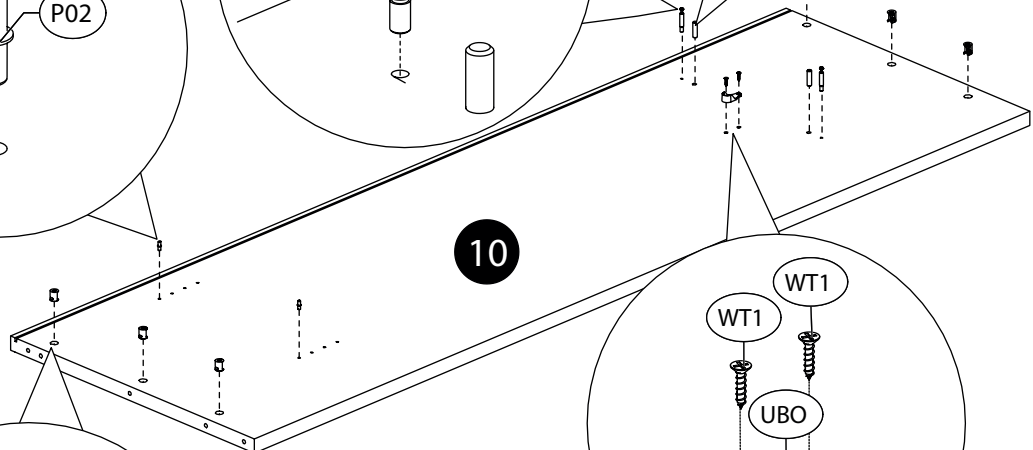
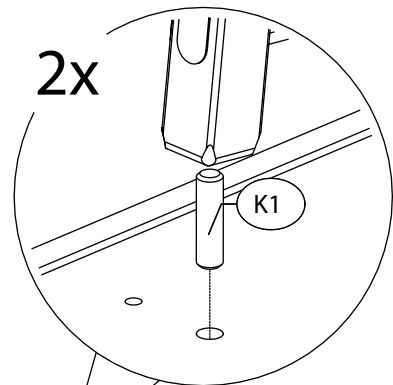

6x

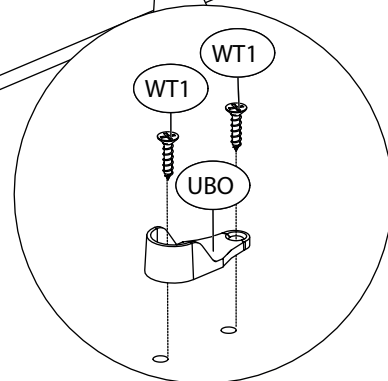
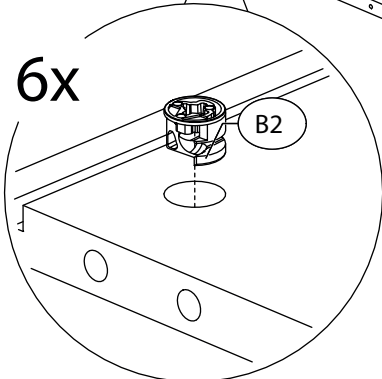

12.

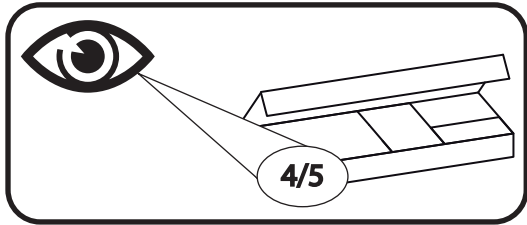

13.

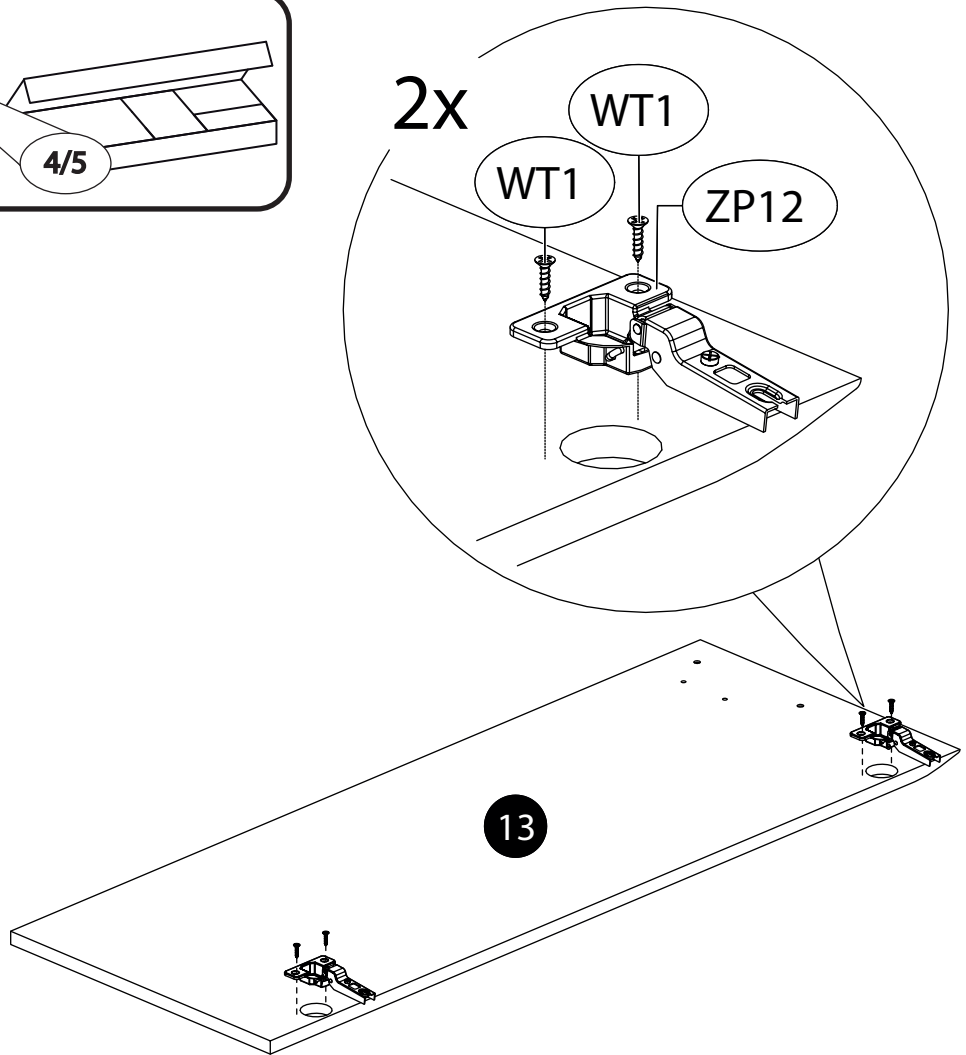

14.

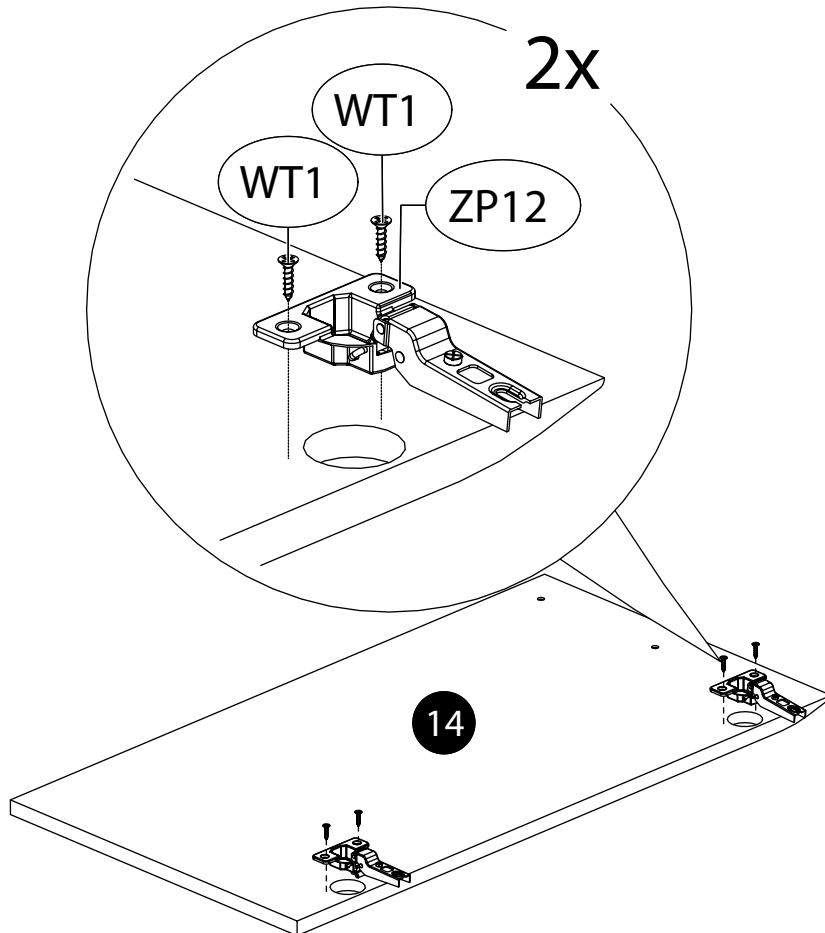

15.

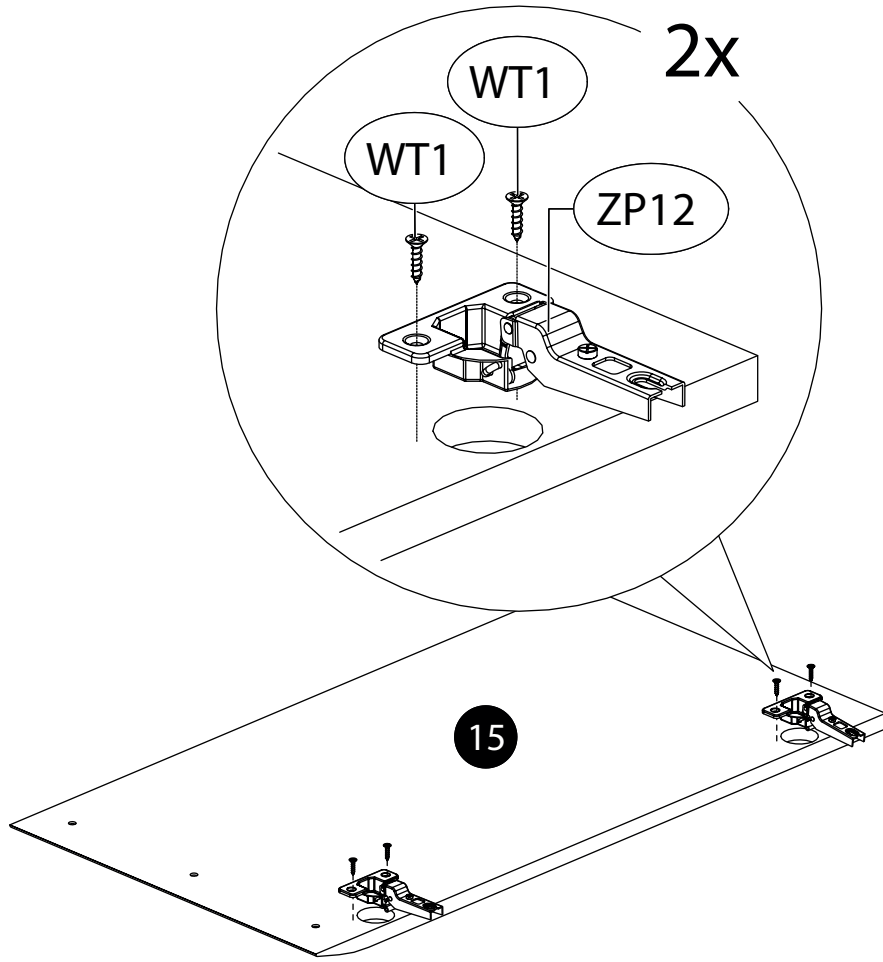

16.

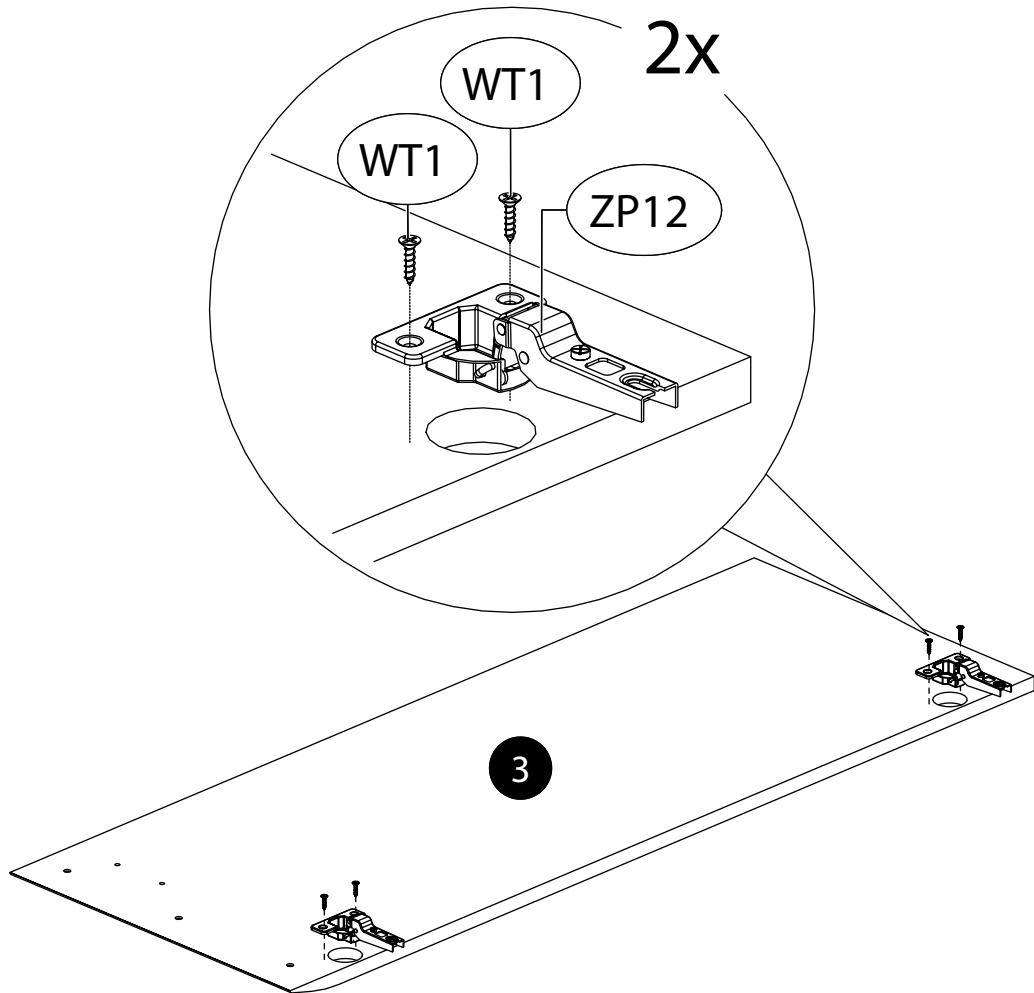

17.

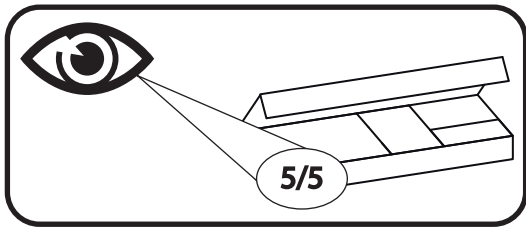

18.

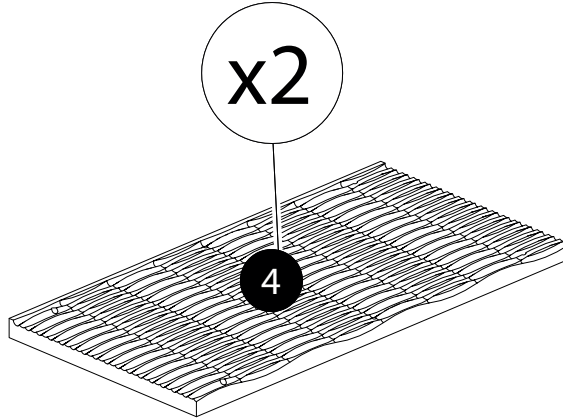

19.

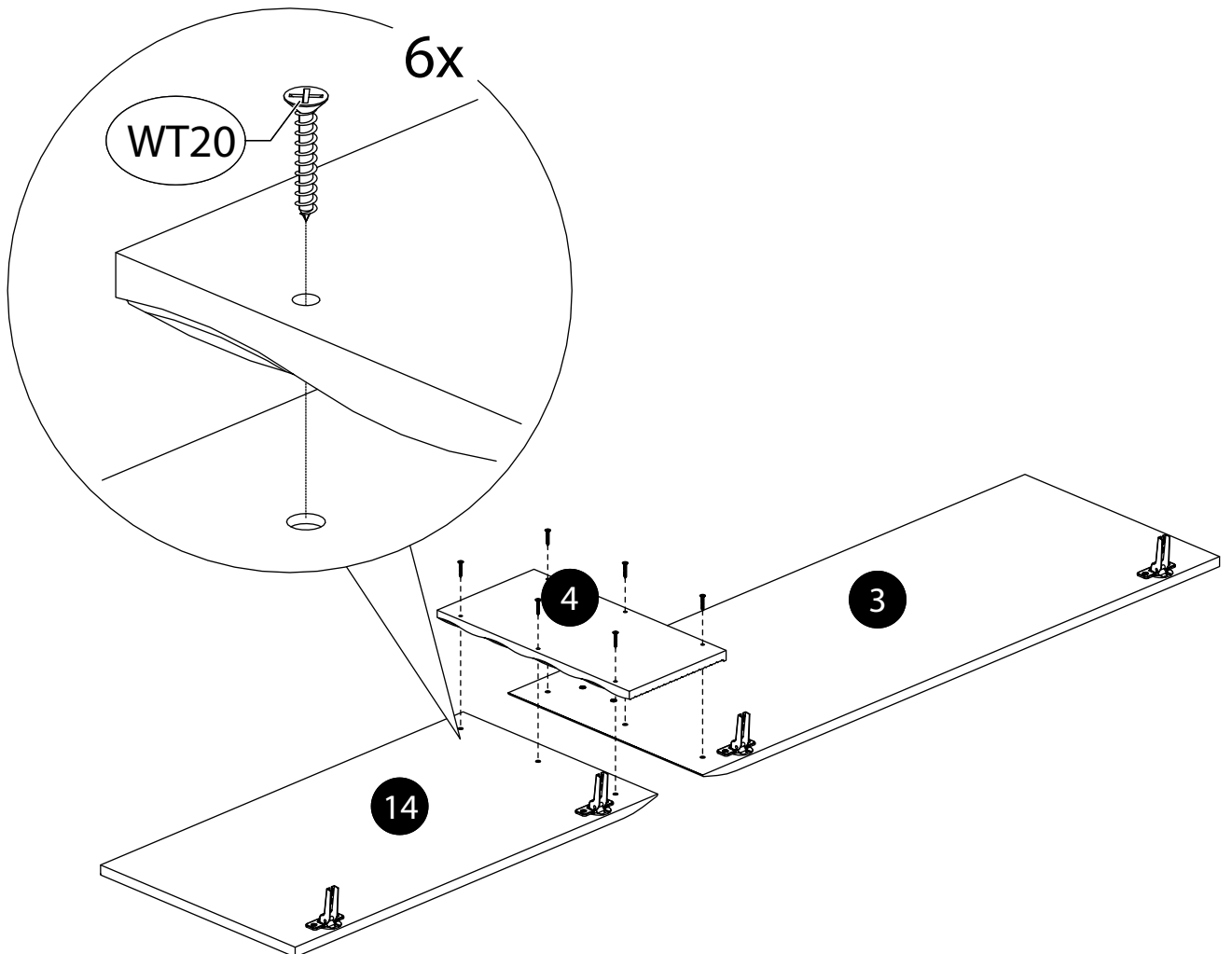

20.

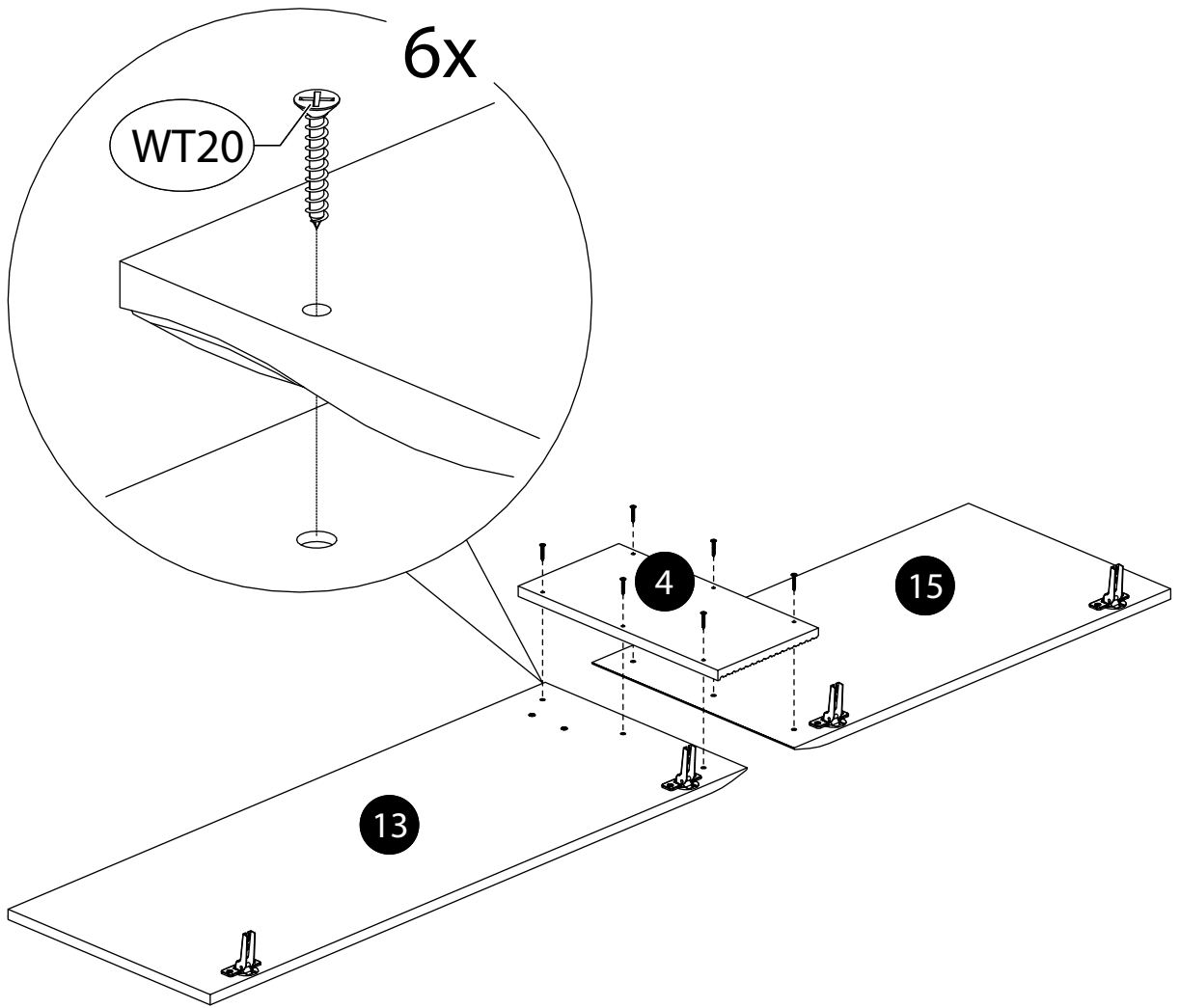

21.

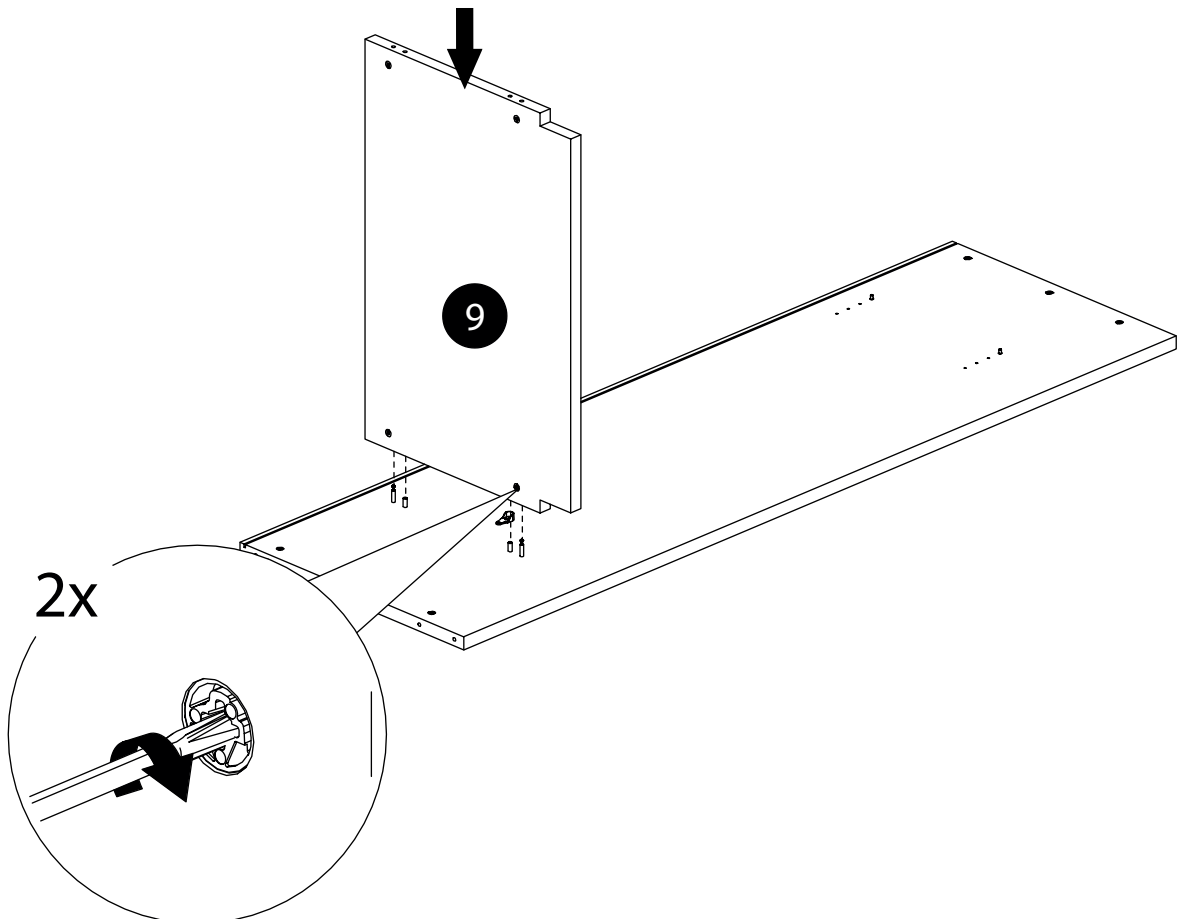

22.

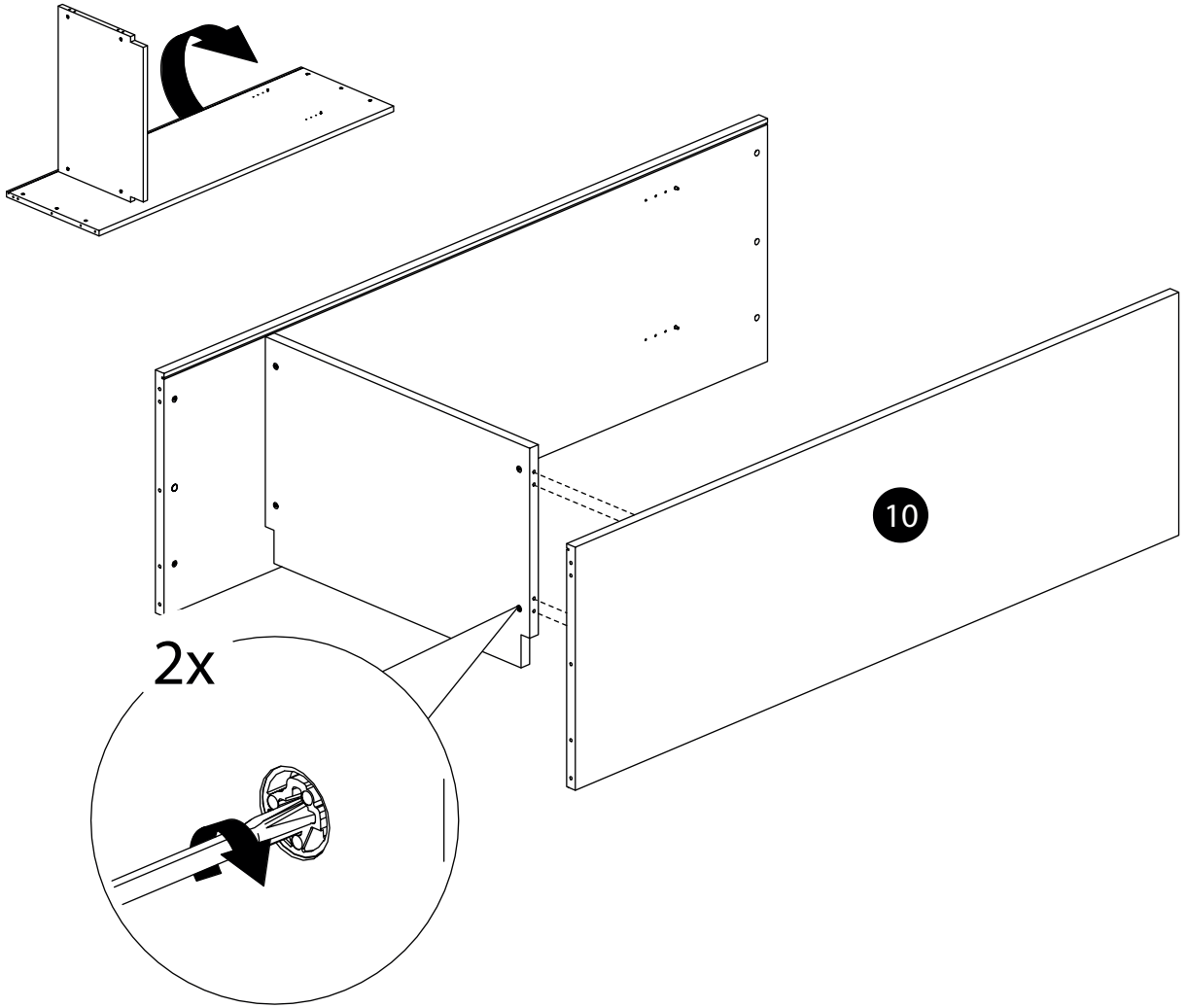

23.

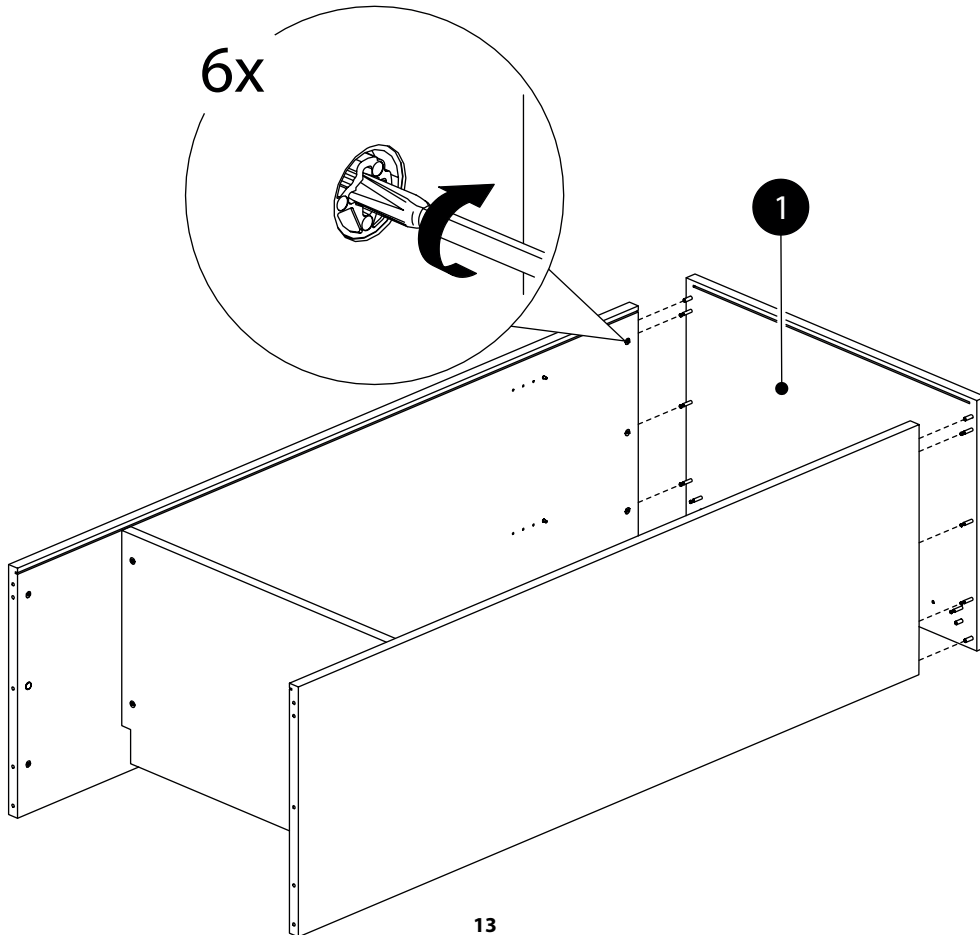

24.

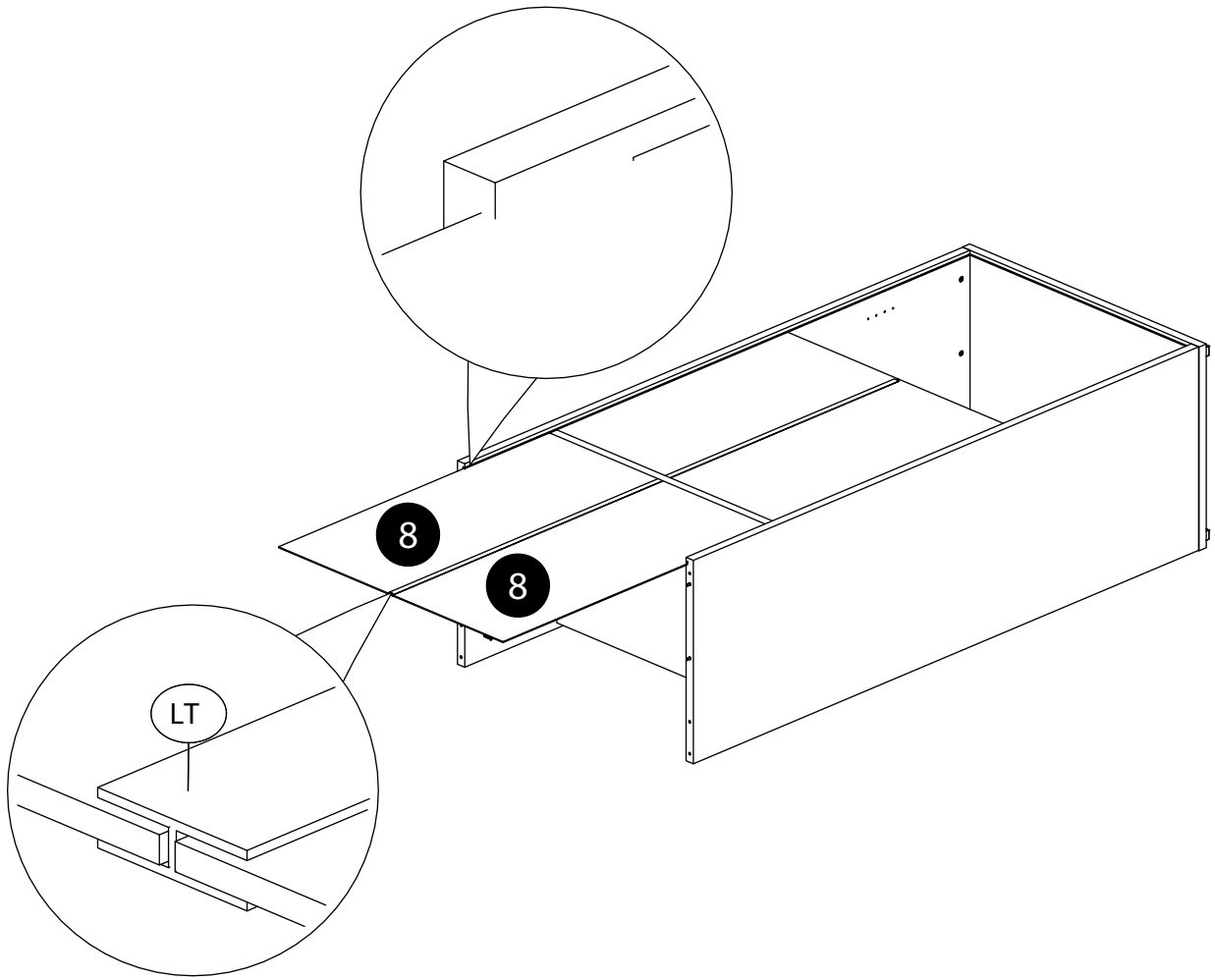

25.

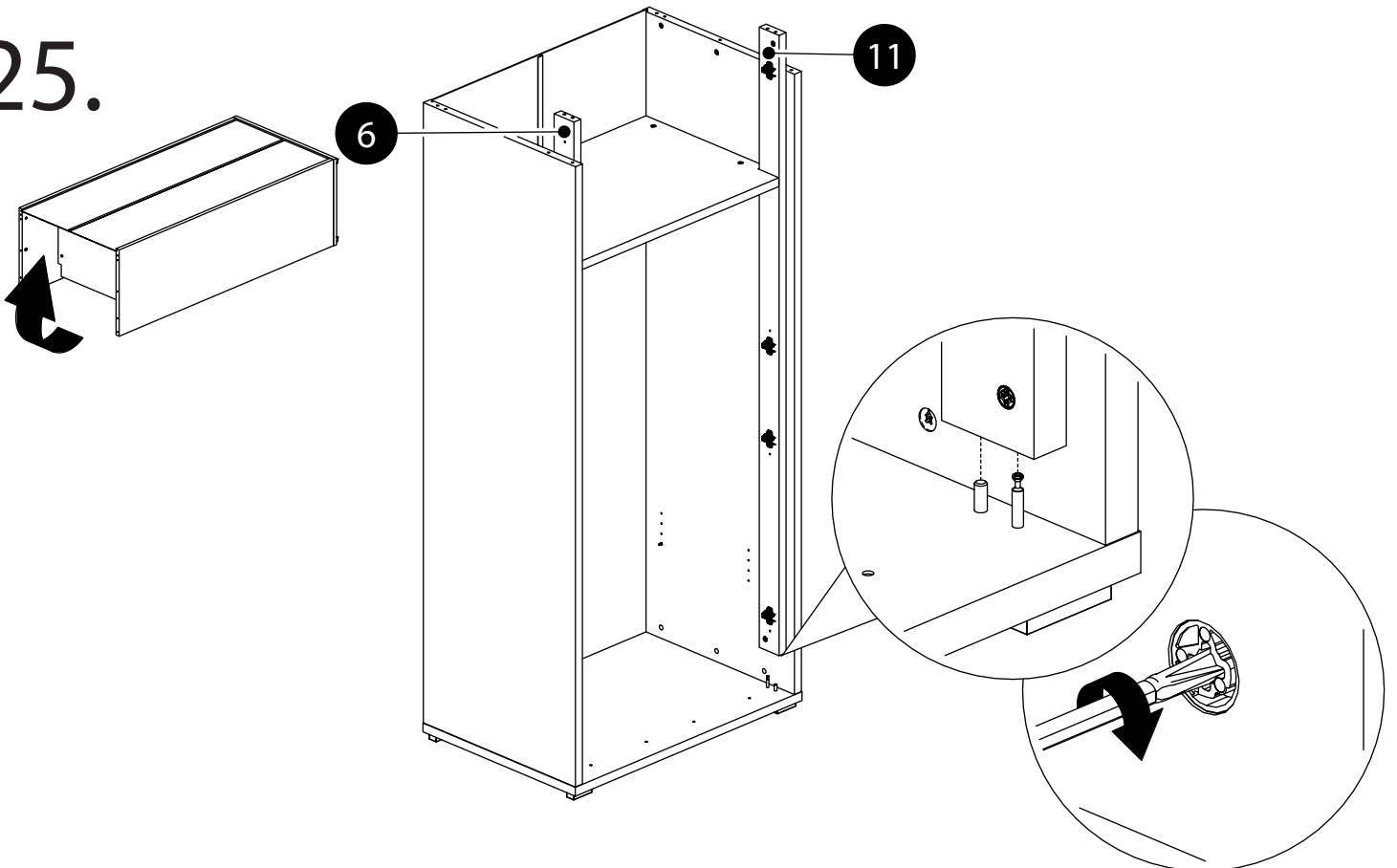

26.

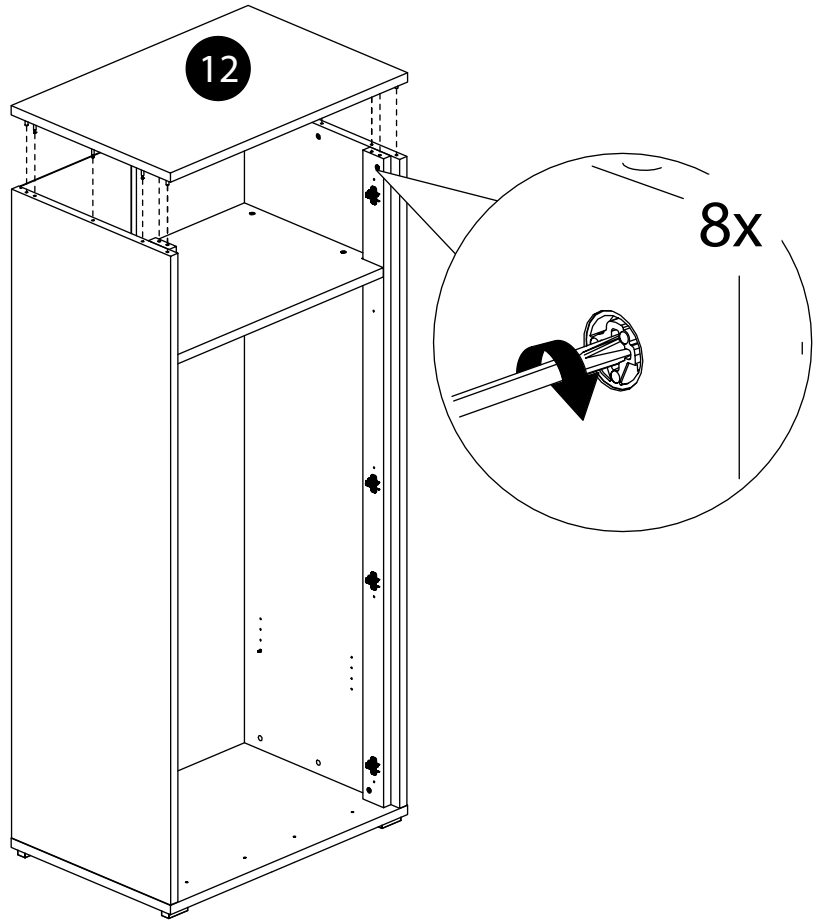

27.

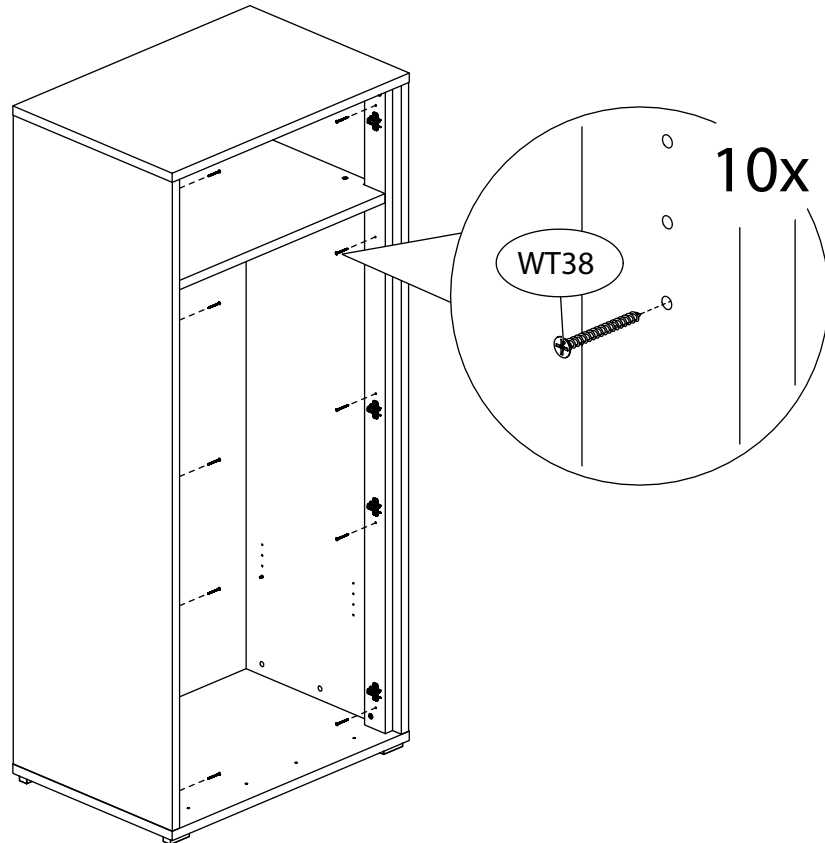

28.

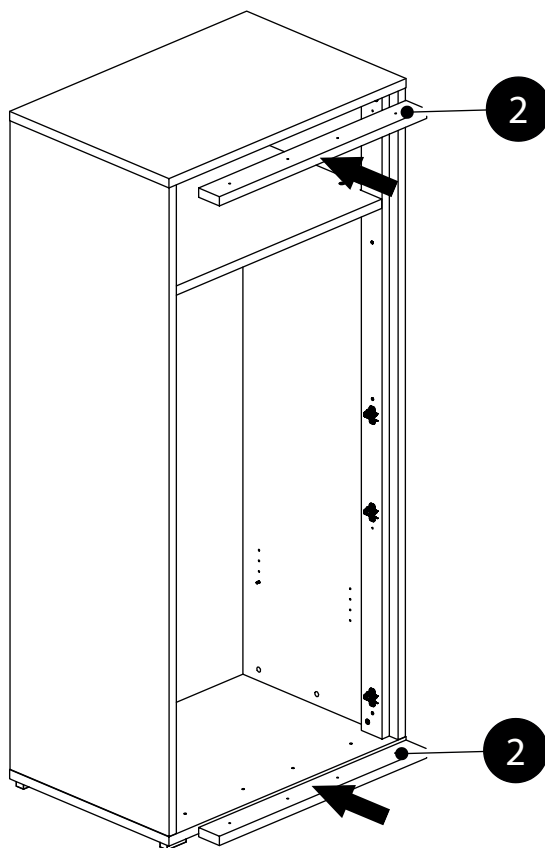

29.

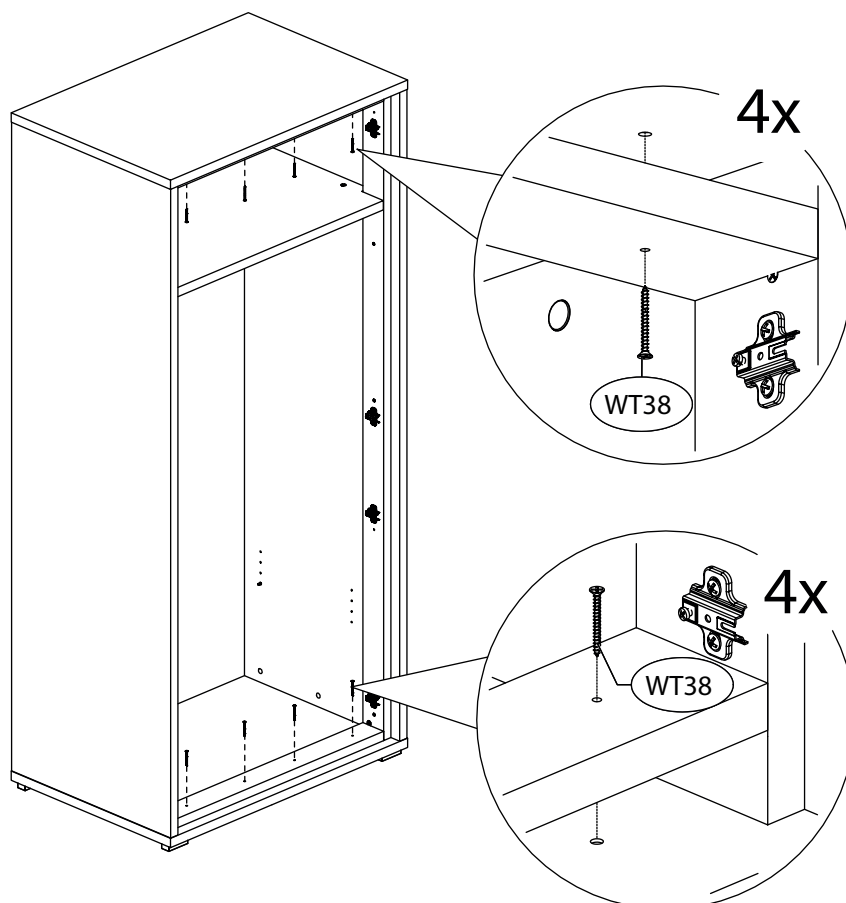

30.

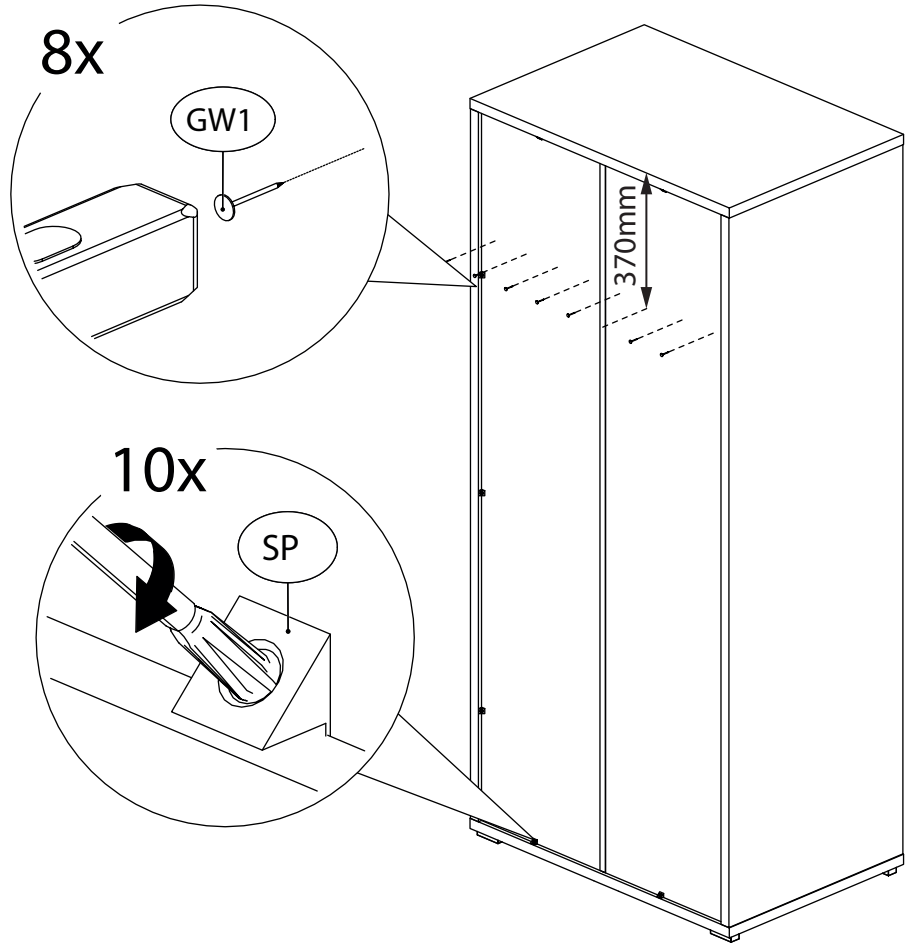
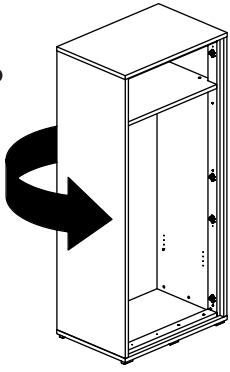

31.

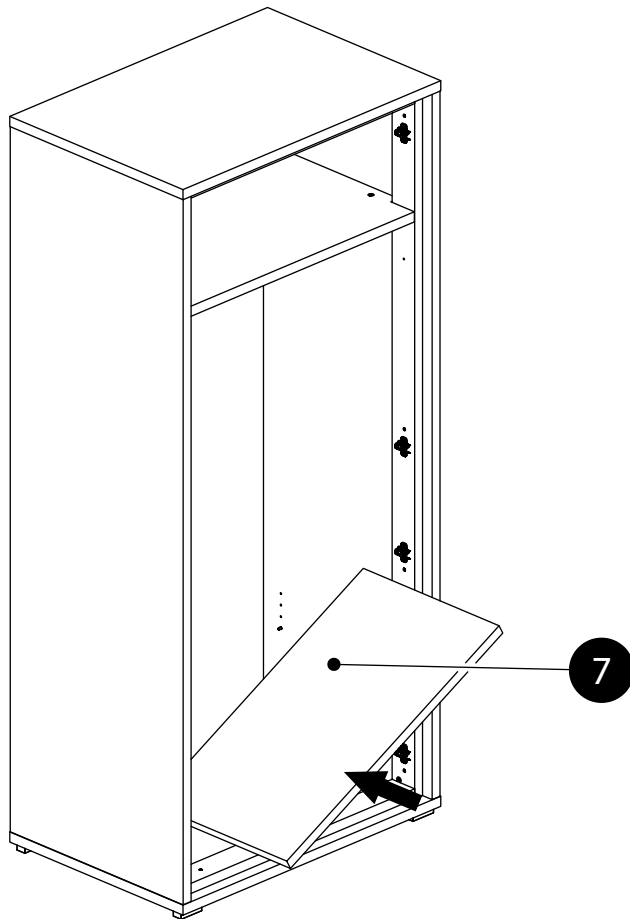
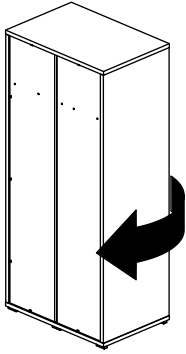

32.

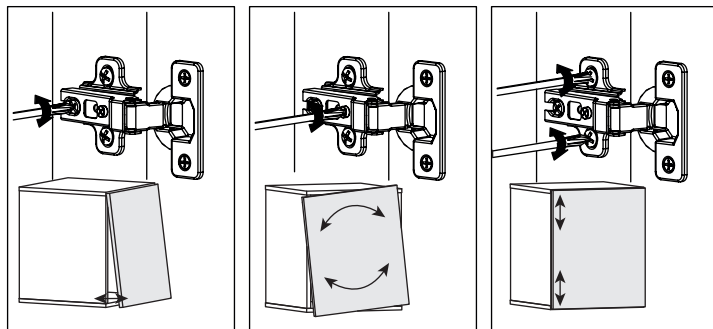
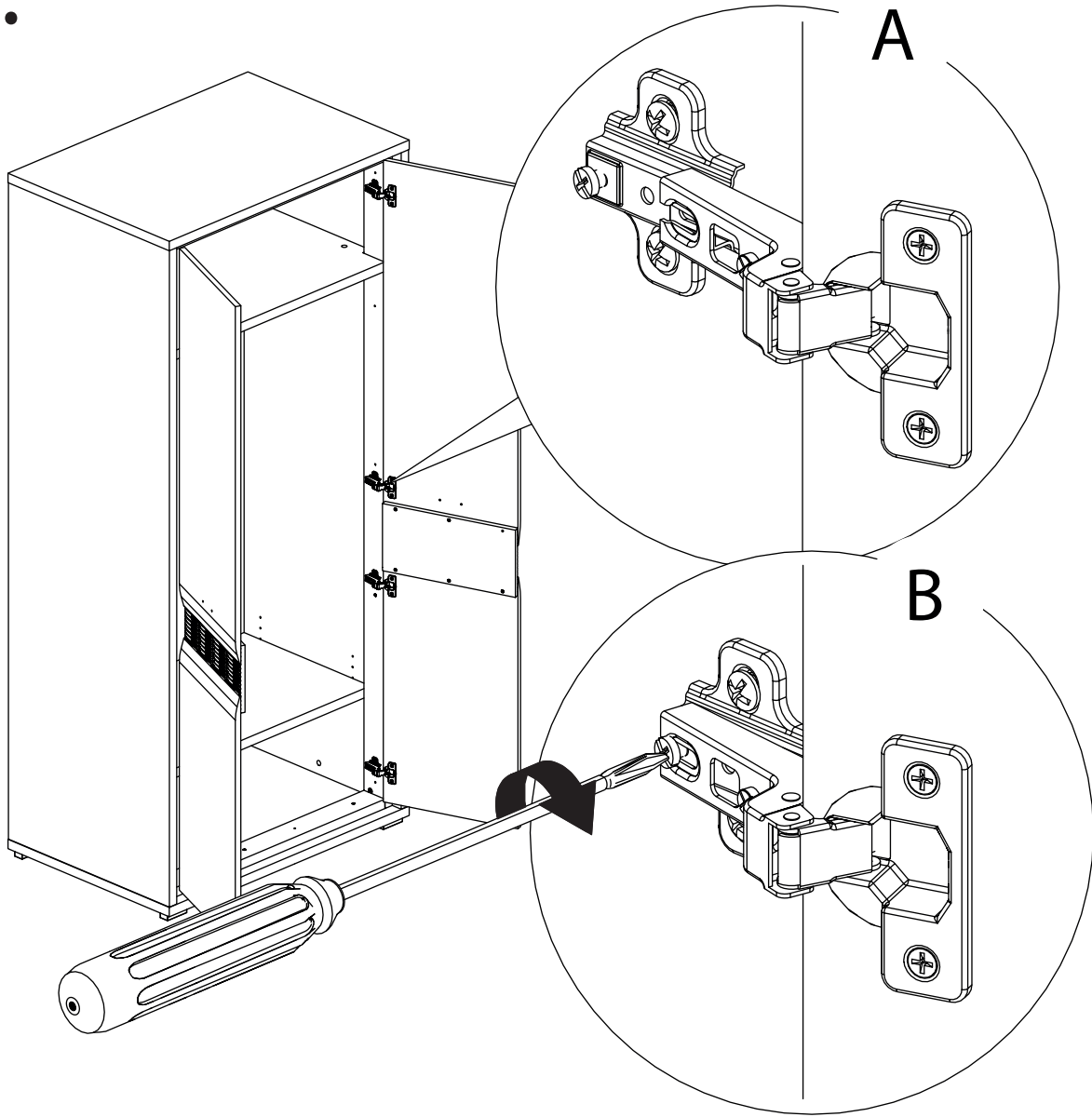

33.

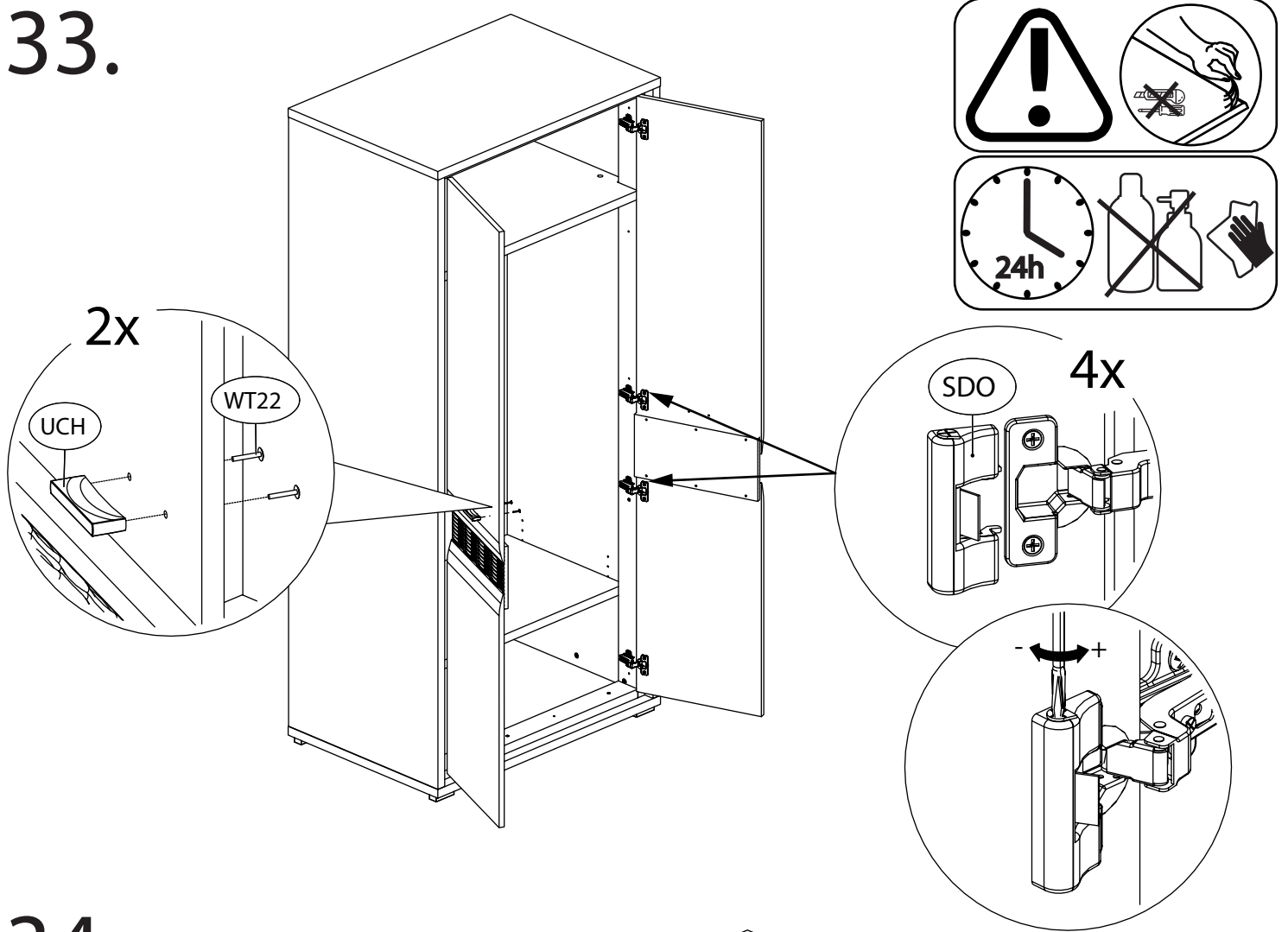

34.

