

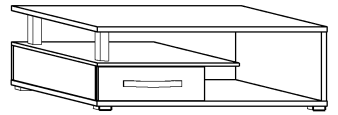

# ANG-07

## ANGEL- ŁAWA

- 118 43 74



x 6



(a)

x 9



(b)

x 6



(c)

x 3



(d)

x 4

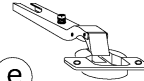

(e)

x 4

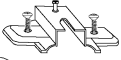

(f)

x 8  
(3,5x16)



(k)

x 8  
(4x20)



(l)

x 4  
(4x25)



(m)

x 2



(n)

x 1

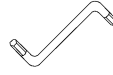

(o)

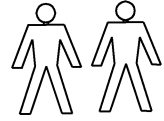

25 min



x 4



(g)

x 2  
186 mm

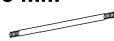

(h)

x 2  
160 mm

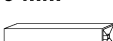

(i)

x 2

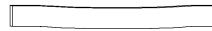

(j)

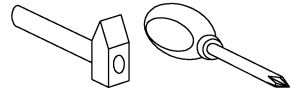

1 - FAZY MONTAŻU

A - OZNACZENIE ELEMENTÓW

a - OZNACZENIE AKCESORIÓW

1

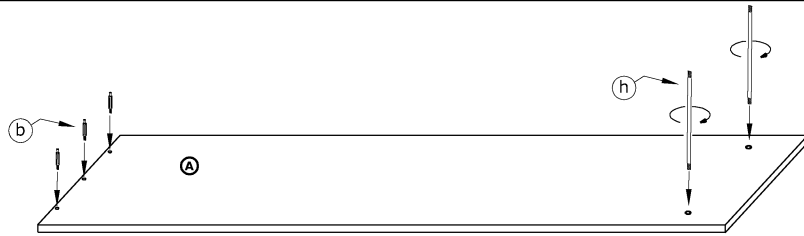
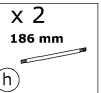

2

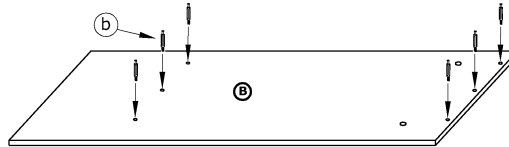
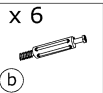

3

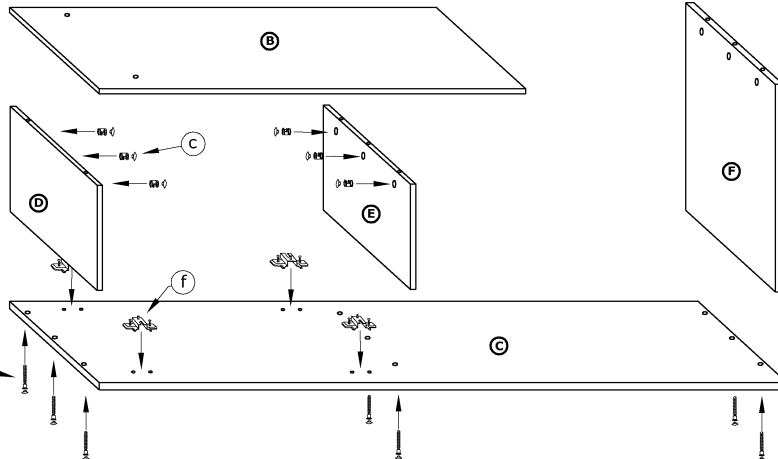
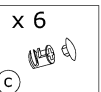
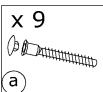

4

