













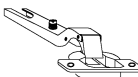
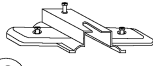





x 2  a	x 6  b	x 6  c	x 16  d	x 4  e	
x 4  f	x 2  g	x 2  j	x 3  m	x 12 (3,5x30)  n	x 44 (3,5x16)  o
x 2 (ø6x18x2)  p	x 12 (6,3-16)  r	x 2 (M4-12)  s	x 2 (ø6)  t	x 30  w	x 1  z
x 2 (214 mm)  h	x 2 kpl.  i	x 4  k		x 1 (812 mm)  l	

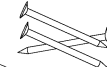

1 - FAZY MONTAŻU

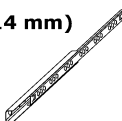
A - OZNACZENIE ELEMENTÓW

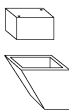
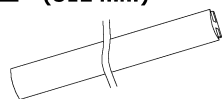
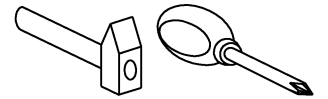
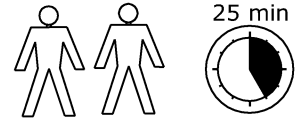
a - OZNACZENIE AKCESORIÓW

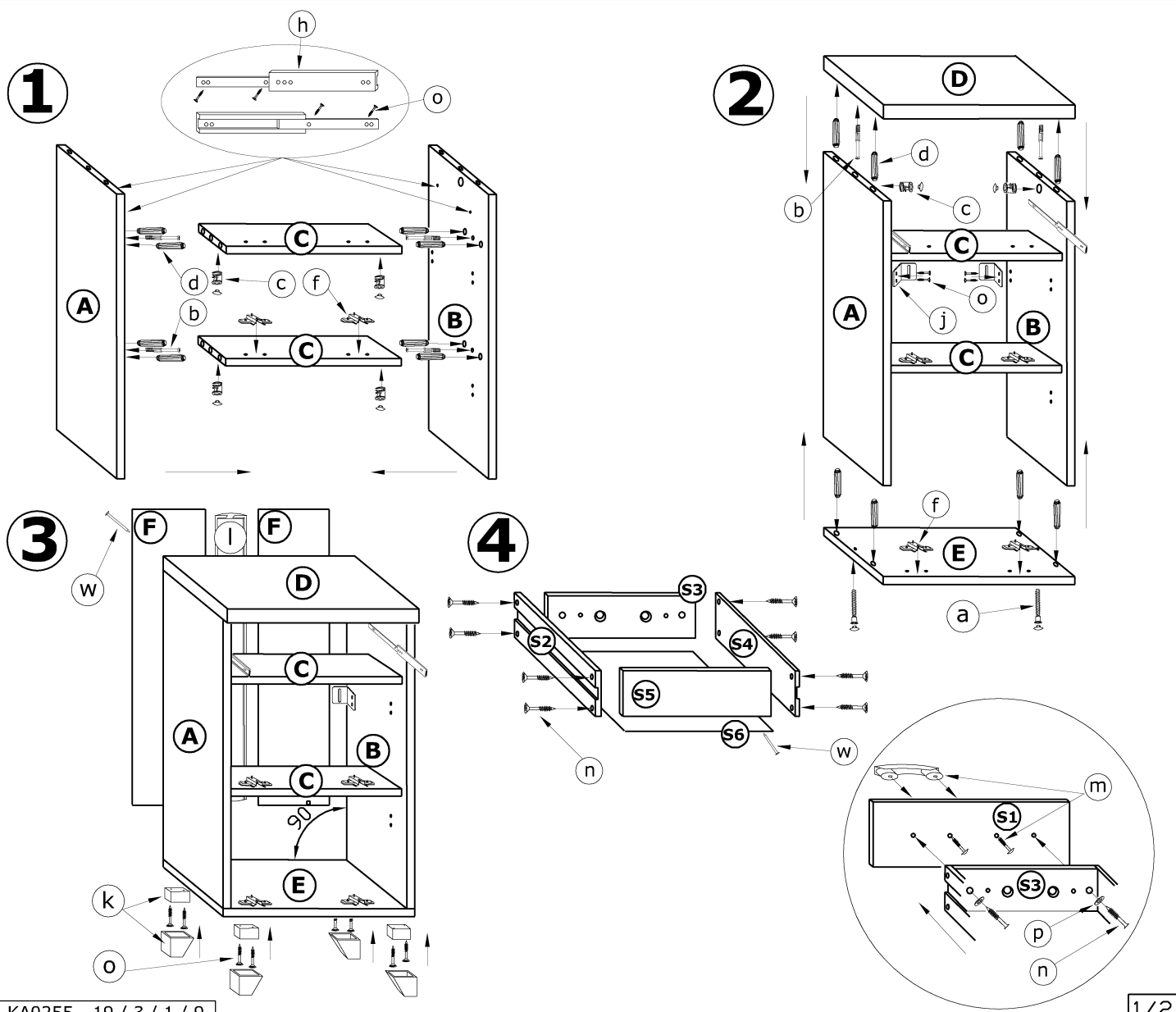

5

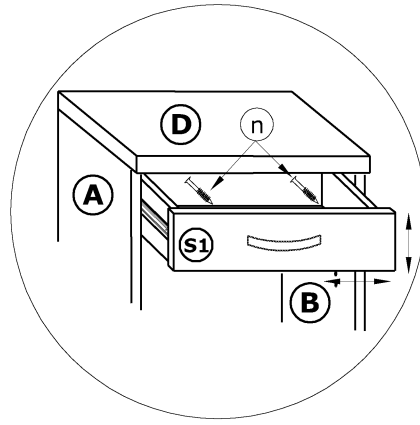
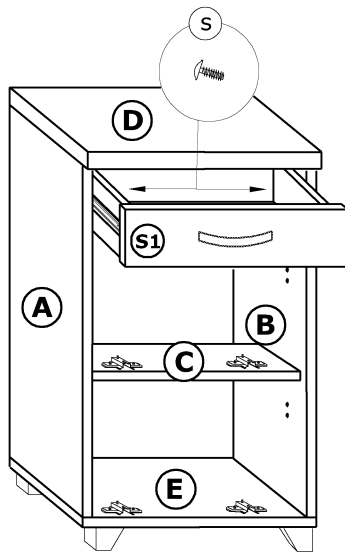

6

