

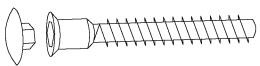









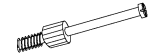

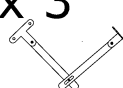

x 10 		x 22 		x 4 	x 4 
x 3 	x 4 	x 4 	x 2 	x 6 	x 2 
x 4 	x 4 (3,5x30) 	x 32 (3,5x16) 	x 40 	x 1 	
x 1 (300 mm - kpl.) 	x 1 (1032 mm) 				

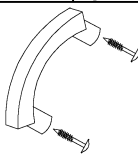

1 - FAZY MONTAŻU

A - OZNACZENIE ELEMENTÓW

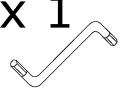
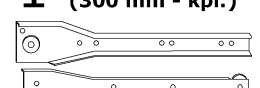
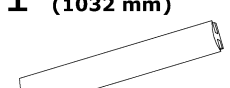
a - OZNACZENIE AKCESORIÓW

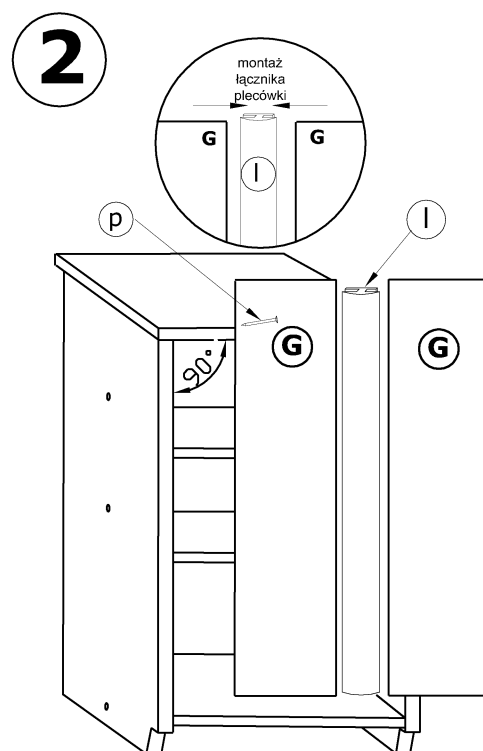
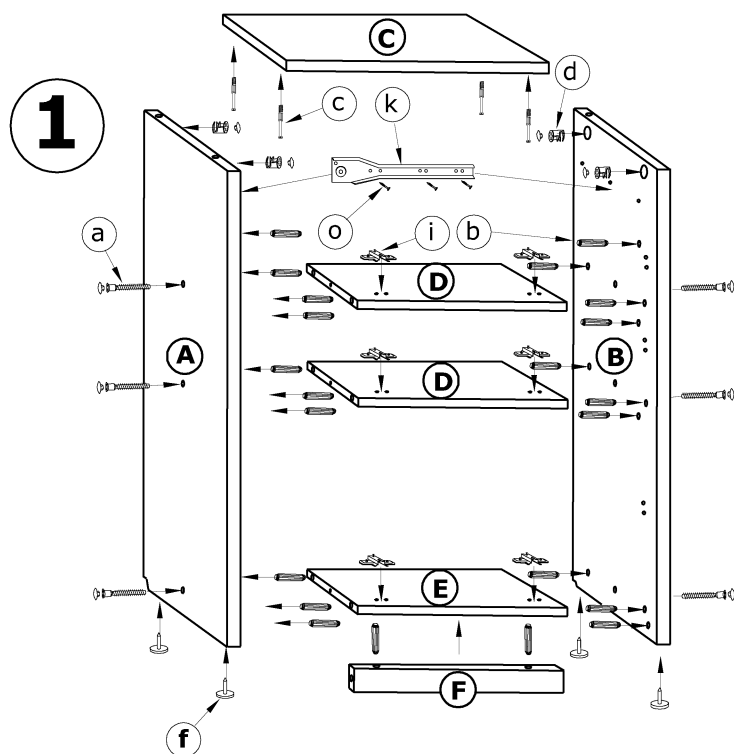

3

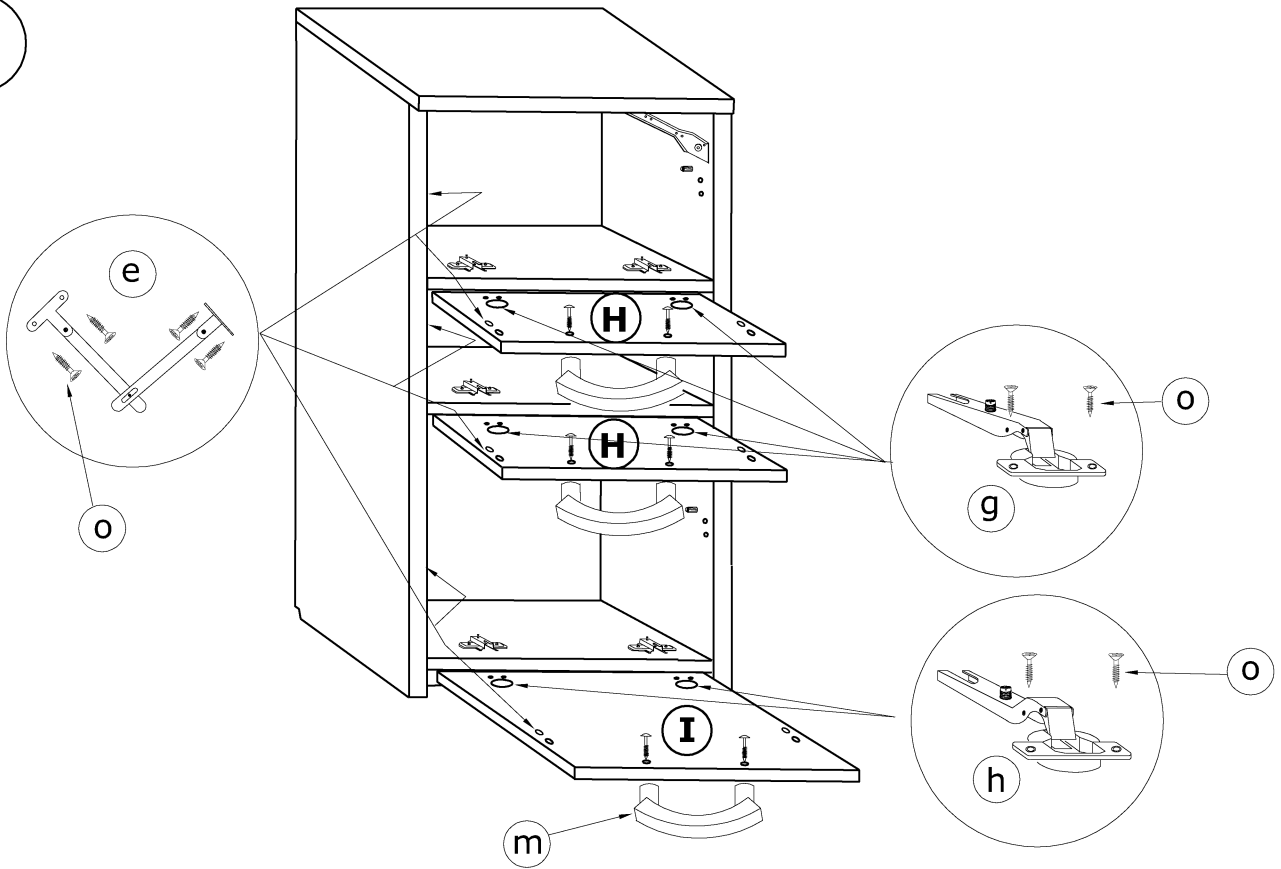

4

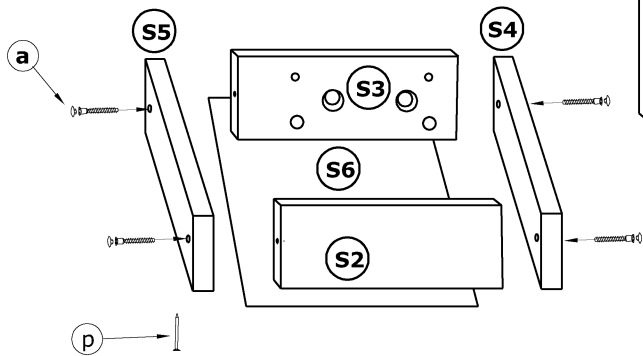

5

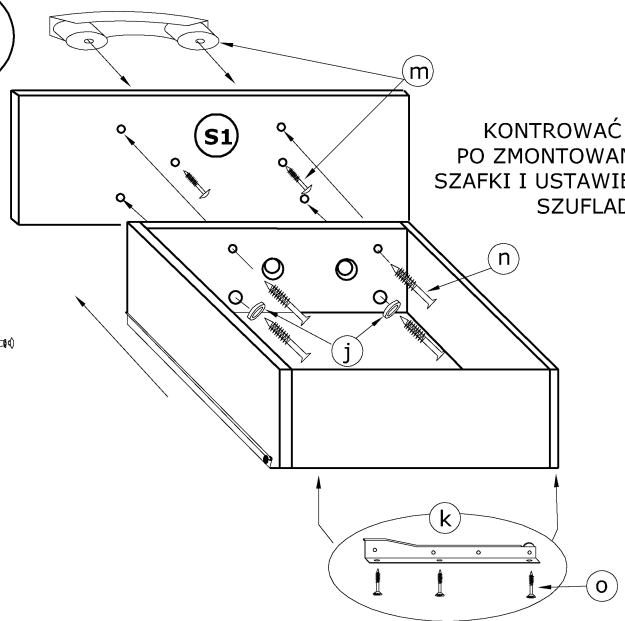

KONTROWAĆ FRONT
PO ZMONTOWANIU CAŁEJ
SZAFKI I USTAWIENIU CZOŁA
SZUFLADY