

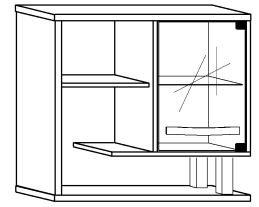

ANG-15

ANGEL- SZAFKA WISZĄCA 1W

→ 80 ↑ 76 ↘ 33



x 16 a	x 12 b	x 4 c	x 5 d	x 1 L e	x 1 P f		
x 2 kpl. g	x 4 (3,5x13) k	x 4 (6,2x13) l	x 2 (4x12) m	x 2 n	x 20 o	x 1 p	
x 2 186 mm h	x 2 160 mm i	x 1 j	 k		 l		 40 min

① - FAZY MONTAŻU

Ⓐ - OZNACZENIE ELEMENTÓW

Ⓐ - OZNACZENIE AKCESORIÓW

1

x 2 a x 2 h

2

x 10 a





3

x 2 a x 1 L e
 x 1 P f x 2 g
 x 4 k x 4 l
 (3,5x13) (6,2x13)

4

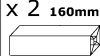

x 2 a
 x 8 b

5

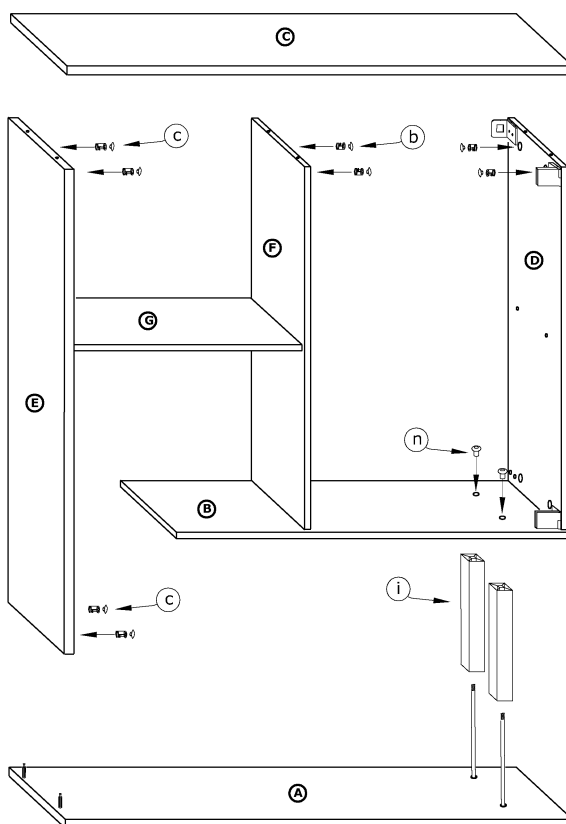
- x 4 
- x 4 
- x 2 160mm 
- x 2 

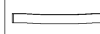

6

- x 5 
- x 1 
- x 4 (4x12) 
- x 20 