

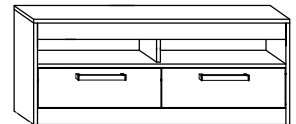













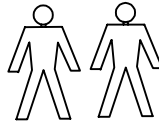



# MXS-34 STOLIK RTV 2S

→ 110 × 46 × 44

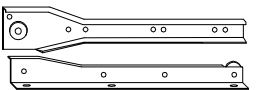

x 9  <b>(a)</b>	x 22  <b>(b)</b>	x 3  <b>(c)</b>	x 25  <b>(d)</b>	x 12  <b>(e)</b>	x 4  <b>(f)</b>	  	
x 5  <b>(g)</b>	x 2  <b>(h)</b>	x 28 (3,5x16)  <b>(i)</b>	x 8 (3,5x30)  <b>(j)</b>	x 2  <b>(k)</b>	x 60  <b>(l)</b>		x 1  <b>(m)</b>
x 2 kpl. (350 mm)  <b>(n)</b>							

**1** - FAZY MONTAŻU

**A** - OZNACZENIE ELEMENTÓW

**a** - OZNACZENIE AKCESORIÓW

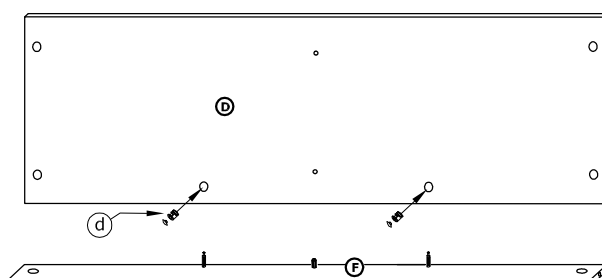
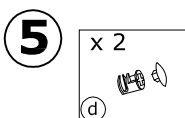
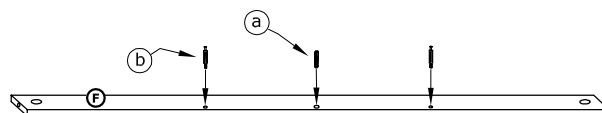
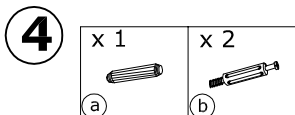
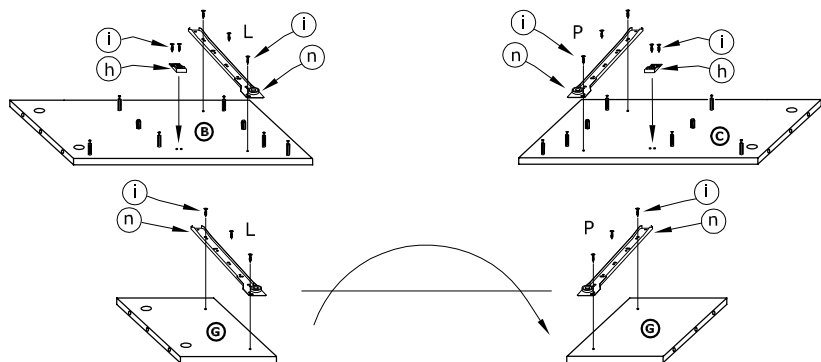
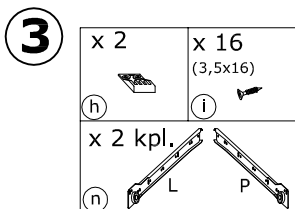
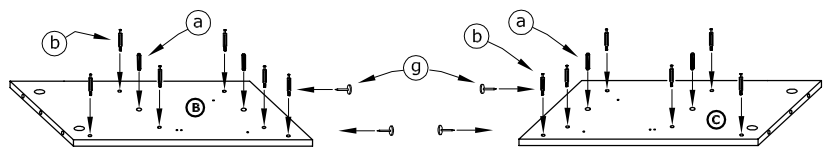
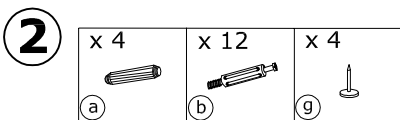
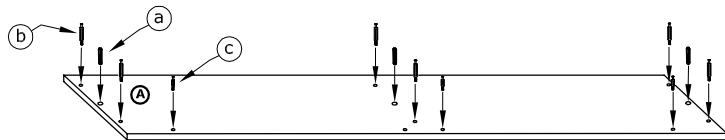
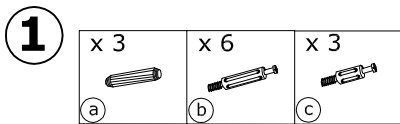

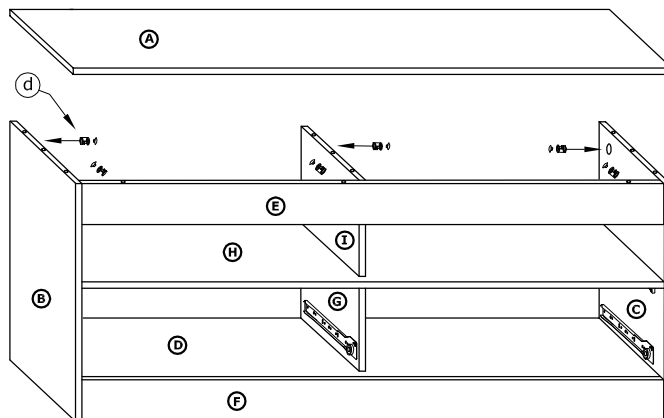
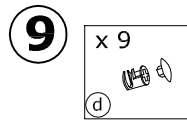
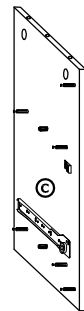
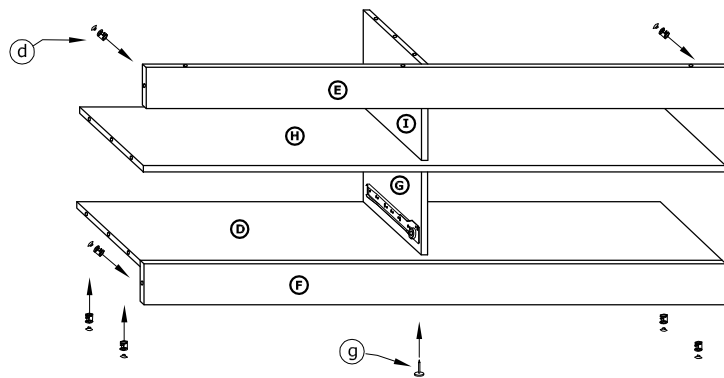
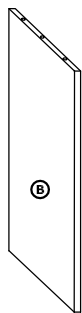
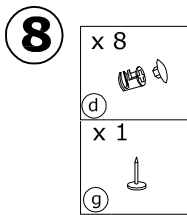
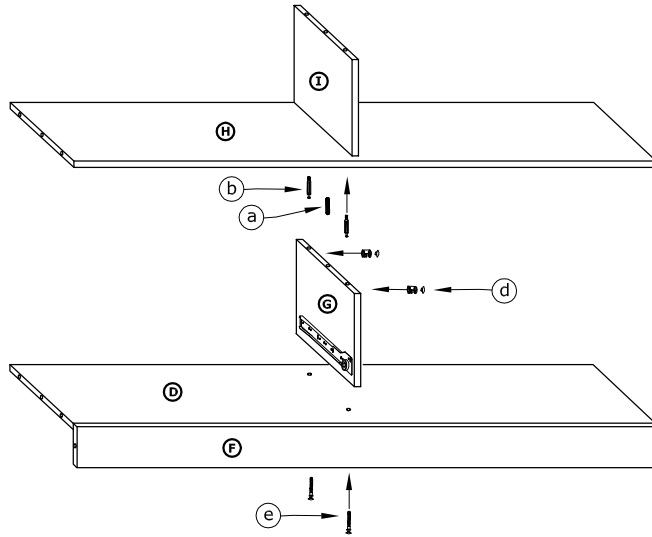
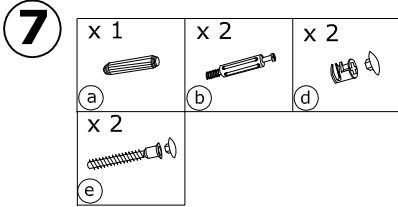
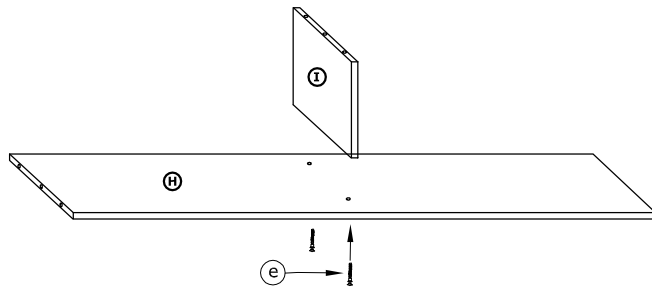
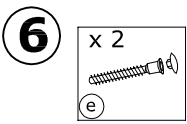

10

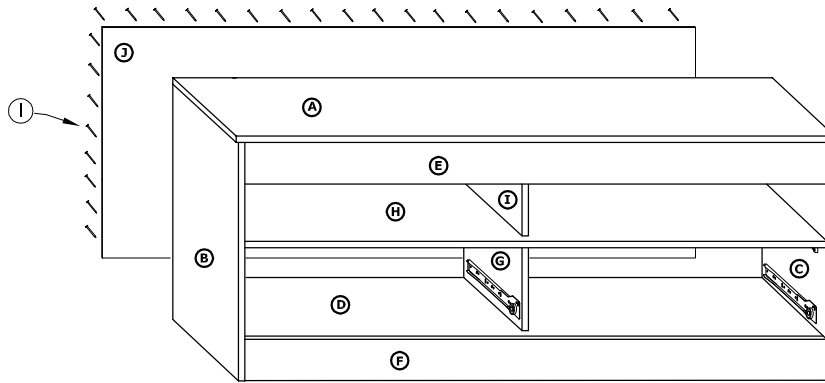
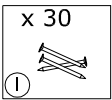

11

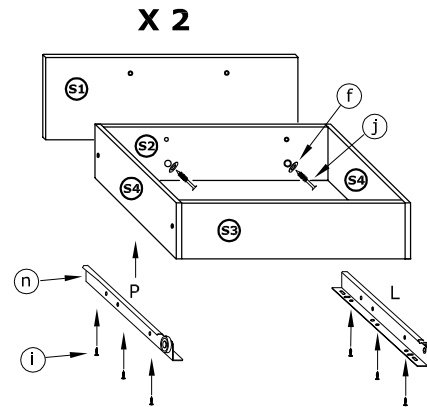
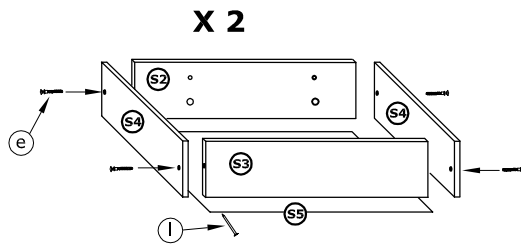
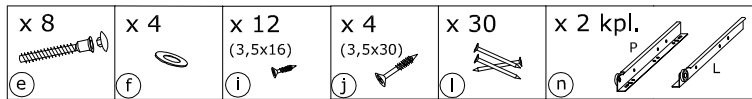

12

